



# EDS3090

## ...91, ...92, ...96



**Portable equipment for insulation fault location  
for energised and deenergised AC and DC systems  
Software version: D399 V2.1**



**Bender GmbH & Co. KG**

PO Box 1161 • 35301 Grünberg • Germany

Londorfer Straße 65 • 35305 Grünberg • Germany

Tel.: +49 6401 807-0 • Fax: +49 6401 807-259

E-mail: [info@bender.de](mailto:info@bender.de) • [www.bender.de](http://www.bender.de)

Photos: Bender archives and bendersystembau archives.

© Bender GmbH & Co. KG  
All rights reserved.  
Reprinting only with permission  
of the publisher.  
Subject to change!

# Table of Contents

<b>1. Important information</b>	<b>7</b>
1.1 How to use this manual	7
1.2 Technical support: Service and support	8
1.2.1 First level support	8
1.2.2 Repair service	8
1.2.3 Field service	8
1.3 Training courses	8
1.4 Delivery conditions	9
1.5 Inspection, transport and storage	9
1.6 Warranty and liability	9
1.7 Disposal	9
1.8 Overview of chapters	10
<b>2. Safety instructions</b>	<b>11</b>
2.1 General safety instructions	11
2.2 Intended use	11
2.3 Device-specific safety instructions	11
<b>3. System description</b>	<b>13</b>
3.1 System components	13
3.1.1 Overview of system components	13
3.1.2 Insulation fault location equipment type list	14
3.1.3 Accessories	15
3.2 Function of the system components	16
3.2.1 Locating current injector PGH18...	16
3.2.2 Insulation fault locator EDS195PM	16
3.2.3 Measuring clamps	16
3.2.4 Coupling device AGE185	17
3.3 Operating principle for insulation fault location (IDL)	17
3.3.1 Schematic diagram EDS system	18
3.3.2 Test cycle	18
3.3.3 Definitions	19
3.3.4 Currents in the EDS system	19
3.4 Operating principle for residual current measurement ( $I_{\Delta n}$ )	20

<b>4. Considerations prior to use .....</b>	<b>21</b>
4.1 How does the equipment for insulation fault location work .....	21
4.2 Requirements for reliable insulation fault location .....	22
4.3 Reduced locating current .....	24
4.4 Response sensitivity characteristics of the EDS195PM .....	24
4.4.1 Response characteristics for main circuits in 3AC systems .....	25
4.4.2 Response characteristics for main circuits in AC systems .....	26
4.4.3 Response characteristics for main circuits in DC systems .....	26
4.4.4 Response characteristics for control circuits in AC systems .....	27
4.4.5 Response characteristics for control circuits in DC systems .....	27
<b>5. Connecting the locating current injector .....</b>	<b>28</b>
5.1 Disconnecting insulation monitoring device .....	28
5.2 Locating current injector in an electrically isolated IT system .....	28
5.3 Connection to a live IT system .....	29
5.4 Connection to a PV system .....	30
<b>6. Operation .....</b>	<b>32</b>
6.1 Short description of insulation fault location (EDS mode) .....	32
6.1.1 Commissioning the PGH18... for locating current injection .....	32
6.1.2 Insulation fault location using EDS195PM .....	32
6.2 Detailed description of insulation fault location .....	32
6.3 Description of a residual current measurement .....	32
6.4 Displays and controls on the PGH18... .....	33
6.5 Displays and controls on the EDS195PM .....	34
6.6 Operating the EDS195PM .....	35
6.6.1 Switching on and off the device .....	35
6.6.2 Changing the measuring clamp .....	36
6.6.3 Improved legibility due to display lighting .....	36
6.6.4 Changing between insulation fault location $I_{\Delta L}$ and residual current measurement $I_{\Delta n}$ operating modes .....	36
6.6.5 Quickly checking the response values for $I_{\Delta L}$ and $I_{\Delta n}$ .....	36
6.6.6 Checking Info menu .....	36
6.6.7 Significance of the display elements .....	37
6.7 Standard displays on the EDS195PM .....	38
6.7.1 EDS measurement ( $I_{\Delta L}$ ) .....	38
6.7.1.1 Standard display if there is no cable to be measured in the clamp .....	38
6.7.1.2 Standard display for EDS measurement ( $I_{\Delta L}$ ) with cable in the clamp .....	38
6.7.1.3 Standard display for measuring faults or pauses between changes in polarity of the measuring pulse .....	38
6.7.2 RCM measurement ( $I_{\Delta n}$ ) .....	38
6.7.2.1 Standard display for RCM measurement ( $I_{\Delta n}$ ) with cable in the clamp .....	38

6.8	Alarms during EDS measurement or RCM measurement .....	39
6.9	Indication of device and measuring errors .....	39
6.10	Factory settings EDS195PM (state as supplied) .....	40
6.11	Menu structure .....	41
6.11.1	Navigating in the menu .....	42
6.11.2	Menu item: Settings .....	42
6.11.3	Menu item: System .....	43
6.11.4	Menu item: Harmonics .....	43
6.11.5	Menu item: I $\Delta$ L alarms .....	43
6.11.6	Menu item: I $\Delta$ n logger .....	44
6.12	Practical usage .....	44
6.12.1	Insulation fault location in a system without a permanently installed EDS system .....	44
6.12.2	Insulation fault location in a system with a permanently installed EDS system ..	47
6.12.3	Insulation fault location in diode-decoupled DC systems .....	49
6.12.4	Usage of the EDS195PM as a residual current meter .....	51
6.12.5	Indication of the harmonics during residual current measurement .....	52
6.13	Coupling device AGE185 for higher system voltages .....	53
6.14	Power supply for the EDS195PM .....	54
6.14.1	Displaying charge state .....	54
6.14.2	Changing batteries .....	54
6.14.3	Power supply unit supplied .....	54
<b>7.</b>	<b>Technical specifications .....</b>	<b>55</b>
7.1	Technical specifications for the system EDS309... .....	55
7.2	Technical specifications PGH18... .....	55
7.3	Technical specifications EDS195PM .....	56
7.4	Technical specifications measuring clamps .....	57
7.5	Technical specifications AGE185 .....	57
7.6	Standards and certifications .....	58
7.7	Change log .....	58
7.8	Dimension diagrams .....	59
7.9	Status word .....	60
7.10	Ordering data including accessories .....	61
7.11	Component list .....	62
<b>8.</b>	<b>Additional fault location information using the EDS309x .....</b>	<b>63</b>
8.1	Required equipment: .....	63
8.2	Collecting and analysing information .....	63
8.3	Taking measurements .....	64
<b>INDEX</b>	<b>.....</b>	<b>70</b>

---

---

# 1. Important information

## 1.1 How to use this manual

Always keep this manual within easy reach for future reference.

To make it easier for you to understand and revisit certain sections in this manual, we have used symbols to identify important instructions and information. The meaning of these symbols is explained below::



*The signal word indicates that there is a **high** risk danger that **will** result in **electrocution** or **serious injury** if not avoided.*



*This signal word means that there is a **medium** risk of danger that can lead to **death** or **serious injury**, if not avoided.*



*This signal word indicates a **low level risk** that can result in minor or **moderate injury** or **damage to property** if not avoided.*



*This symbol denotes information intended to assist the user to make **optimum use of the product**.*



*This manual is intended for qualified personnel working in electrical engineering and electronics!*

## 1.2 Technical support: Service and support

For commissioning and troubleshooting Bender offers you:

### 1.2.1 First level support

Technical support by phone or e-mail for all Bender products

- Questions concerning specific customer applications
- Commissioning
- Troubleshooting

Telephone:	+49 6401 807-760*
Fax:	+49 6401 807-259
In Germany only:	0700BenderHelp (Tel. and Fax)
E-Mail:	support@bender-service.de

### 1.2.2 Repair service

Repair, calibration, update and replacement service for Bender products

- Repairing, calibrating, testing and analysing Bender products
- Hardware and software update for Bender devices
- Delivery of replacement devices in the event of faulty or incorrectly delivered Bender devices
- Extended warranty for Bender devices with in-house repair service or replacement device at no extra cost

Telephone:	+49 6401 807-780** (technical issues)
	+49 6401 807-784**, -785** (Sales)
Fax:	+49 6401 807-789
E-Mail:	repair@bender-service.de

### 1.2.3 Field service

On-site service for all Bender products

- Commissioning, parameter setting, maintenance, troubleshooting for Bender products
- Analysis of the electrical installation in the building (power quality test, EMC test, thermography)
- Training courses for customers

Telephone:	+49 6401 807-752**, -762** (technical issues)
	+49 6401 807-753** (Sales)
Fax:	+49 6401 807-759
E-Mail:	fieldservice@bender-service.de
Internet:	www.bender.de

\*Available from 7.00 a.m. to 8.00 p.m. 365 days a year (CET/UTC+1)

\*\*Mon-Thurs 7.00 a.m. - 8.00 p.m., Fr 7.00 a.m. - 13.00 p.m.

## 1.3 Training courses

Bender is happy to provide training regarding the use of test equipment.

The dates of training courses and workshops can be found on the Internet at [www.bender-de.com](http://www.bender-de.com) -> Know-how -> Seminars.



## 1.4 Delivery conditions

Bender sale and delivery conditions apply. For software products, the "Softwareklausel zur Überlassung von Standard-Software als Teil von Lieferungen, Ergänzung und Änderung der Allgemeinen Lieferbedingungen für Erzeugnisse und Leistungen der Elektroindustrie" (software clause in respect of the licensing of standard software as part of deliveries, modifications and changes to general delivery conditions for products and services in the electrical industry) set out by the ZVEI (Zentralverband Elektrotechnik- und Elektronikindustrie e.V.) (German Electrical and Electronic Manufacturers' Association) also applies.

Sale and delivery conditions can be obtained from Bender in printed or electronic format.

## 1.5 Inspection, transport and storage

Inspect the dispatch and equipment packaging for damage, and compare the contents of the package with the delivery documents. In the event of damage in transit, please contact Bender immediately. The devices must only be stored in areas where they are protected from dust, damp, and spray and dripping water, and in which the specified storage temperatures can be ensured.

## 1.6 Warranty and liability

Warranty and liability claims in the event of injury to persons or damage to property are excluded if they can be attributed to one or more of the following causes:  
Improper use of the device.

- Incorrect mounting, commissioning, operation and maintenance of the device.
- Failure to observe the instructions in this operating manual regarding transport, commissioning, operation and maintenance of the device.
- Unauthorised changes to the device made by parties other than the manufacturer.
- Non-observance of technical data.
- Repairs carried out incorrectly and the use of replacement parts or accessories not approved by the manufacturer.
- Catastrophes caused by external influences and force majeure.
- Mounting and installation with device combinations not recommended by the manufacturer.
- This operating manual, especially the safety instructions, must be observed by all personnel working on the device. Furthermore, the rules and regulations that apply for accident prevention at the place of use must be observed.

## 1.7 Disposal

Abide by the national regulations and laws governing the disposal of this device. Ask your supplier if you are not sure how to dispose of the old equipment.

The directive on waste electrical and electronic equipment (WEEE directive) and the directive on the restriction of certain hazardous substances in electrical and electronic equipment (RoHS directive) apply in the European Community. In Germany, these policies are implemented through the "Electrical and Electronic Equipment Act" (ElektroG). According to this, the following applies:

- Electrical and electronic equipment are not part of household waste.
- Batteries and accumulators are not part of household waste and must be disposed of in accordance with the regulations.
- Old electrical and electronic equipment from users other than private households which was introduced to the market after 13th August 2005 must be taken back by the manufacturer and disposed of properly.

For more information on the disposal of Bender devices, refer to our homepage at [www.bender.de](http://www.bender.de)  
-> Service & support.

## 1.8 Overview of chapters

1. How to get the most out of this manual:  
This chapter provides information about using this documentation.
2. Safety instructions:  
This section provides information about risks affecting installation and operation.
3. System description:  
In this chapter you will find an overview of the system components, a description of their function and the basic principles of insulation fault location.  
The principle of residual current measurement is described in the final section.
4. Considerations prior to use:  
This chapter describes the practical aspects of insulation fault location and provides numerous characteristic curves for assessing the response values to be set.
5. Connecting the locating current injector:  
The connection of the PGH18... to a system to be tested is described here.
6. Operation:  
This chapter contains a description of the graphical user interface on the EDS195PM. There is also an illustration of the menu structure as well as illustrations of the various standard displays.  
You will also find information of the supply of power to the EDS195PM here.
7. Technical specifications:  
Along with tabular data this chapter contains information on standards and the dimensions of the system components.
8. Frequently Asked Questions:  
Use this chapter to quickly identify and rectify any malfunctions that occur.
9. INDEX:  
Use the index to quickly find the desired keywords.

## 2. Safety instructions

### 2.1 General safety instructions

Part of the device documentation in addition to this manual is the enclosed "Safety instructions for Bender products."

### 2.2 Intended use



*Only skilled persons are permitted to carry out the work necessary to install, commission and run a device or system.*

The portable insulation fault location system EDS309... is used to locate insulation faults in IT systems. All variants are suitable for the measurement of residual currents in TN and TT systems. The EDS3096PG is particularly suitable for insulation fault location in electrically isolated systems.

Please observe the limits on the area of application stated in the technical specifications, as well as the measuring categories for the measuring clamps used. If, in the specific case, measuring current transformers other than the measuring clamps supplied are used with the EDS195PM, attention is to be paid to ensuring the connection wires and transformer have an adequate nominal insulation voltage (overvoltage category, see Technical specifications)

Use which deviates from or is beyond the scope of these technical specifications is considered non-compliant.



**CAUTION**

*System interference and high system leakage capacitances can degrade the accuracy of the measurement.*

## 2.3 Device-specific safety instructions



### CAUTION

#### **Hazard due to excessively high locating current or excessively high locating voltage!**

An excessively high PGH18... locating current may damage sensitive loads (e.g. in control circuits) or trigger unintended switching processes. For this reason select a lower locating current for these systems (1 or 10 mA).

For instance it is only allowed to use the EDS3091 or EDS3091PG in systems with programmable logic controllers (PLCs).

The locating voltage of DC 50 V produced by the locating current injector PGH186 can cause interference at sensitive system components. In case of doubt, contact Bender.

The locating current from the PGH185 or PGH186 can cause residual current devices to trip. The locating current is limited to maximum 25 mA (or 10 mA), however 30 mA residual current devices may trip, for instance, between 15 and 30 mA.



It is necessary to aim for the best possible conductor symmetry in the measuring clamp. Otherwise the measuring clamp may go into saturation due to an excessively high load current and cause an alarm  $I_{\Delta n} > 10A$ .

## 3. System description

### 3.1 System components

On page 63, you will find a detailed overview of the scope of delivery of the EDS309x versions. The following illustration provides a choice of the possible components.

#### 3.1.1 Overview of system components

The primary task of the EDS309... is insulation fault location in IT systems. For this purpose the individual components of the EDS309... are used in combination.

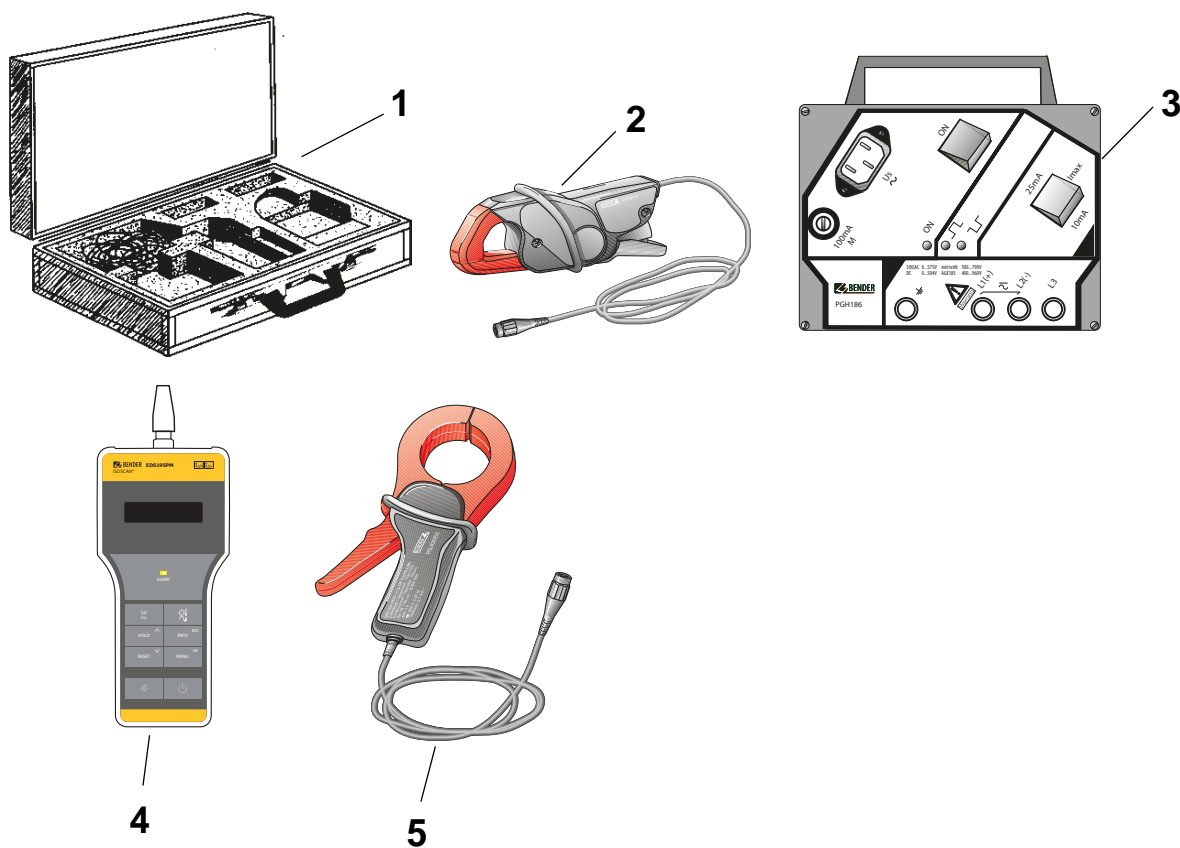

1	Aluminium case with handle
2	Measuring clamp PSA3020 (main circuits) or PSA3320 (control circuits) Clamp inside diameter 20 mm
3	Locating current injector PGH18... For generating a locating current for insulation fault location
4	Insulation fault locator EDS195PM For connecting measuring clamps and for finding insulation faults
5	Measuring clamp PSA3052 (main circuits) or PSA3352 (control circuits) Clamp inside diameter 52 mm

### 3.1.2 Insulation fault location equipment type list

It is possible to undertake a residual current measurement in TT and TN systems (earthed systems) using all the device variants listed below.

The following overview describes which measuring tasks can be undertaken with which models:

#### Equipment for insulation fault location in main circuits

##### 1. Permissible system voltage in the main circuits:

- Insulation fault location in IT systems up to AC 42...460 Hz, 20...575 V and DC 20...504 V
- Insulation fault location using AGE185 up to AC 42...460 Hz, 500...790 V and DC 400...960 V

#### EDS3090:

- Can be used in IT systems in which a locating current injector PGH471 or an IRDH575, iso685-x-P or isoxx1685xP is already installed.

#### EDS3090PG:

- Can be used in IT systems in which neither a locating current injector PGH471 nor an IRDH575, iso685-x-P or isoxx1685xP is already installed.
- Supply voltage for the locating current generator PGH185 supplied:  
AC 50...60 Hz, 230 V

#### EDS3090PG-13:

- Can be used in IT systems in which neither a locating current injector PGH471 nor an IRDH575, iso685-x-P or isoxx1685xP is already installed.
- Supply voltage for the locating current generator PGH185-13 supplied:  
AC 50...60 Hz, 90...132 V

##### 2. Permissible system voltage in the main circuits:

- Insulation fault location in IT systems up to AC 42...460 Hz, 0...575 V and DC 0...504 V
- Insulation fault location using AGE185 up to AC 42...460, Hz 500...790 V and DC 400...960 V

#### EDS3096PG:

- Can be used in IT systems in which neither a locating current injector PGH471 nor an IRDH575, iso685-x-P or isoxx1685xP is already installed.
- Supply voltage for the locating current generator PGH186 supplied:  
AC 50...60 Hz, 230 V
- Insulation fault location, also in IT systems electrically isolated on all poles

#### EDS3096PG-13:

- Can be used in IT systems in which neither a locating current injector PGH471 nor an IRDH575, iso685-x-P or isoxx1685xP is already installed.
- Supply voltage for the locating current generator PGH186-13 supplied:  
AC 50...60 Hz, 90...132 V
- Insulation fault location, also in IT systems electrically isolated on all poles

#### EDS3096PV:

- Applicable in PV systems without a locating current injector installed.
- Supply voltage for the delivered locating current injector PGH186: AC 50...60 Hz, 230 V.
- Insulation fault location, also in IT systems disconnected on all poles or in de-energised IT systems.

**Accessories CTAFxxx:**

- Set with flexible clamps with band lengths of 500 and 1000 mm
- Application for cables with big dimensions or in systems with narrow space conditions
- Combinable with EDS3090, EDS3092, EDS3096
- The minor response sensitivity towards the clamps PSA3... in chapter 4.4 must be considered.

**Equipment for insulation fault location in control circuits**

Permissible system voltage in the control circuits:

Insulation fault location in IT systems up to AC 42...460 Hz, 20...265 V and DC 20...308 V.

**EDS3091:**

- Can be used in IT systems in which a locating current injector PGH473 or an IRDH575, iso685-x-P or isoxx1685xP is already installed.

**EDS3091PG:**

- Can be used in IT systems in which neither a locating current injector PGH473 nor an IRDH575, iso685-x-P or isoxx1685xP is already installed.
- Supply voltage for the locating current generator PGH183 supplied:  
AC 50...60 Hz, 230 V

**EDS3091PG-13:**

- Can be used in IT systems in which neither a locating current injector PGH473 nor an IRDH575, iso685-x-P or isoxx1685xP is already installed.
- Supply voltage for the locating current generator PGH183-13 supplied:  
AC 50...60 Hz, 90...132 V

**Equipment for insulation fault location in main circuits and control circuits****EDS3092PG:**

- Contains the components and combines the features of the EDS3090PG and EDS3091PG

**3.1.3 Accessories**

You will find information on the standard accessories as well as on optional accessories in the ordering data on page 62 and in the component list on page 63.



*Only use the components supplied by us on working with the EDS309.... Commercially available measuring clamps are not allowed to be used! This statement also applies to measuring clamps or measuring current transformers from the Bender range that are not expressly intended to be used with the EDS309.... Along with the measuring clamps supplied, it is allowed to connect to the EDS195PM the following measuring current transformers from the Bender series:  
WF...  
W.../WR.../WS...  
W...-8000/WS...-8000  
Series W...AB current transformers **cannot** be used!*

For series WF... current transformers you will need a BNC to PS2 adapter cable, see page 62.

## 3.2 Function of the system components

### 3.2.1 Locating current injector PGH18...

The PGH18... generates a defined locating current. The magnitude of the current is dependent on the insulation fault present and the system voltage.

- The PGH185 or PGH186 limits the locating current to maximum 25 mA or maximum 10 mA depending on the switch setting.
- The PGH183 limits the locating current to maximum 2.5 mA or maximum 1 mA depending on the switch setting.
- The PGH186 applies the locating current in electrically isolated IT systems or in IT systems with a system voltage < 50 V using an integrated voltage source (DC 50 V). In IT systems with a system voltage > 50 V the existing voltage in the system is used to drive the locating current.

### 3.2.2 Insulation fault locator EDS195PM

The insulation fault locator EDS195PM has the following measuring functions:

- Insulation fault location  $I_{\Delta L}$  (EDS mode) for use in IT AC or DC systems:
  - Either as a component of the portable equipment for insulation fault location EDS309...
  - Or as an additional insulation fault locator in permanently installed equipment for insulation fault location with IRDH575, iso685-x-P or isoxx1685xP or PGH1... as well as EDS4....
- Residual current measurement  $I_{\Delta n}$  (RCM mode) for usage in TN or TT AC systems. The response value range can be found in table 3.1 on page 16.

#### Response value

The response value is defined by the sensitivity of the EDS195PM. This value can be set in both DC and AC and 3AC IT systems as an arithmetic mean in accordance with table 3.1 on page 16. System interference and high system leakage capacitances can degrade the accuracy.

### 3.2.3 Measuring clamps

Measuring clamps measure the locating current or the residual current. They have a test lead approx. 2 m long. The connection to the EDS195PM is made using a BNC connection.

The following table summarises the most important data for the usage of the different measuring clamps.

		Main circuit (EDS3090..., 3092..., 3096...)		Control circuit (EDS3091...)
IT system	Meas. clamps	PSA3020, PSA3052, PSA3165	CTAF	PSA3320, PSA3352
	Meas. range	2...50 mA	10...50 mA	0,2...5 mA
	Response value	2...10 mA, $\pm 30\%$ / $\pm 2$ mA	10 mA, $\pm 30\%$ / $\pm 2$ mA	0,2...1 mA, $\pm 30\%$ / $\pm 0,2$ mA
TN/TT system	Meas. clamps	PSA3020, PSA3052, PSA3165		PSA3320, PSA3352
	Meas. range	5 mA...10 A		2 mA...2 A
	Response value	10 mA...10 A		5 mA...1 A

Tab. 3.1: Measuring clamps and response values for the EDS195PM

If measuring current transformers are used instead of measuring clamps, you will need the adapter supplied: BNC/4-mm connector. See table on page 63



### 3.2.4 Coupling device AGE185

The coupling device AGE185 expands the nominal voltage range of the equipment for insulation fault location EDS309.... It enables the equipment to be connected to system nominal voltages up to AC 790 V or DC 960 V.

## 3.3 Operating principle for insulation fault location ( $I_{\Delta L}$ )

On the occurrence of the first insulation fault in IT systems a residual current flows that is essentially defined by the system leakage capacitances. The basic concept of fault location is therefore to briefly close the fault circuit using a defined resistance. With this principle a locating current is provided by the system voltage and this locating current contains a signal that can be evaluated.

The locating current is generated periodically by the locating current injector PGH18... (part of the EDS309...PG system).

The locating current can also be generated by an iso685-D-P, isoxx1685xP, IRDH575 or a locating current injector PGH47....

The amplitude and duration of the locating current is limited. During this process the system conductors are alternately connected to earth via a defined resistance. The locating current produced as a result is dependent on the magnitude of the insulation fault present and the system voltage.

For example the locating current on the EDS3090 is limited to maximum 25 mA; with the setting  $I_{\max} = 10\text{mA}$  it is limited to 10 mA. During planning it is to be ensured that there are no system components in which this locating current could cause a reaction involving damage in unfavourable circumstances.

The locating current pulse flows from the locating current injector through the live conductors to the insulation fault by the shortest route. From there it flows via the insulation fault and the earth cable (PE cable) back to the locating current injector. This locating current pulse is detected by the measuring clamps or measuring current transformers in the insulation fault path and is indicated by the insulation fault locator EDS195PM connected.



*You must ensure that all live conductors are routed through the measuring clamp. **Do not route any protective earth conductors or screens on screened cables through the measuring clamp!** Commercial measuring clamps are not suitable for the EDS309... and must not be used.*

*Only if these notes are observed will you obtain a correct measurement result. You will find additional information in our technical information Techinfo08 "Transformer installation".*

### 3.3.1 Schematic diagram EDS system

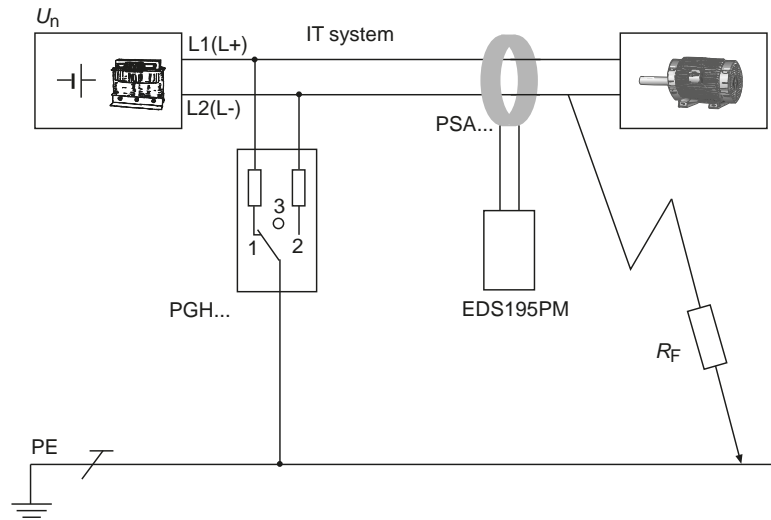

EDS195PM	Insulation fault locator
PGH...	Locating current injector
$U_n$	IT system voltage
PSA...	Measuring clamp
$R_F$	Insulation fault
PE	Protective earth conductor

### 3.3.2 Test cycle

The locating current pulse cycle has a duration of 6 seconds. The PGH... sends alternating positive and negative locating current pulses. The sketch below shows the test cycle of the PGH... with the different switch settings (1, 2, 3) on the device, see schematic diagram above.

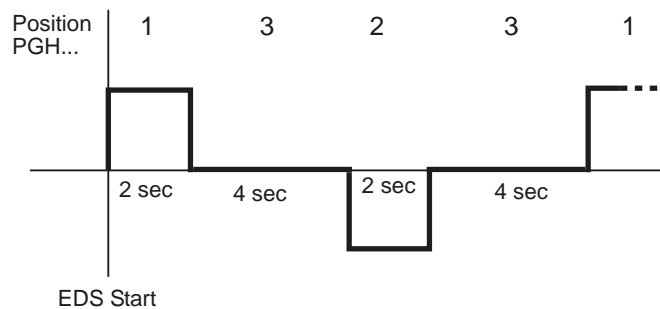

### 3.3.3 Definitions

- $I_L$  = Locating current that flows through the locating current injector while the fault location is running (EDS mode).
- $I_{\Delta L}$  = Locating current measured by the insulation fault locator (EDS mode).
- $I_{\Delta n}$  = Residual current produced by an insulation fault (RCM mode).

### 3.3.4 Currents in the EDS system

As an addition to the schematic diagram on page 18, here the path of the residual currents and the locating current is shown:

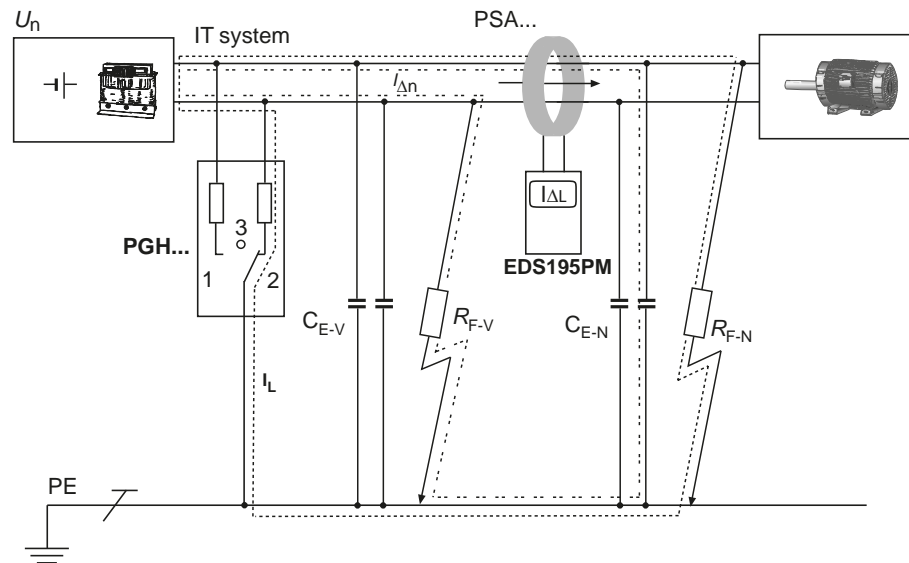

.....	Locating current circuit due to the insulation fault $R_{F-N}$
... ..	Residual currents $I_{\Delta n}$ (example)
$I_{\Delta L}$	Locating current measured by the EDS195PM
$C_{E-V}$	Upstream capacitances, system leakage capacitances upstream of the measuring current transformer
$C_{E-N}$	Downstream capacitances, system leakage capacitance downstream of the measuring current transformer
$R_{F-V}$	Insulation fault upstream of measuring current transformer
$R_{F-N}$	Insulation fault downstream of the measuring current transformer

The following residual currents flow through the measuring current transformer of the EDS195PM:

- The locating current caused by the insulation fault  $R_{F-N}$
- The residual currents  $I_{\Delta n}$  that flow through the system leakage capacitances  $C_{E-V}$  and  $C_{E-N}$ , or that are caused by  $R_{F-V}$  and  $R_{F-N}$
- Transient leakage currents that are caused by switching and control activities in the system
- Low-frequency leakage currents generated by the use of converters

### 3.4 Operating principle for residual current measurement ( $I_{\Delta n}$ )

In the RCM mode the EDS309... operates based on the principle of residual current measurement. In this case only the insulation fault locator EDS195PM and a measuring clamp are used, the locating current injector PGH18... is not required.

As per Kirchhoff's law the sum of the currents flowing into any node in a network is equal to the sum of the currents flowing out.



Abb. 3.1: The two currents  $I_{zu}$  and  $I_{ab}$  have the same magnitude, however their signs are different, such that the sum of the two currents is zero. The EDS195PM detects this situation, there is no message.



Abb. 3.2: Part of the current flows through an insulation fault  $R_F$ . The sum of the two currents is no longer zero. As soon as the residual current reaches or exceeds the response value there is an alarm message on the EDS195PM.

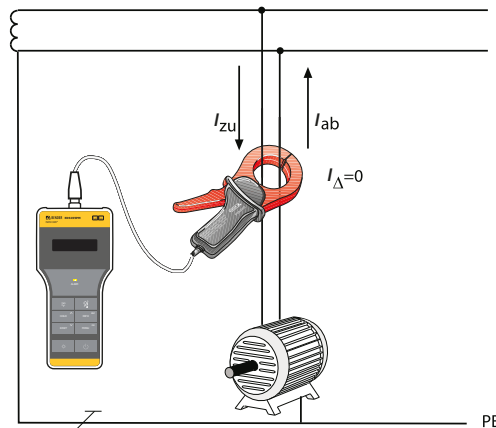

In the RCM mode it is possible to measure residual currents in single and three-phase TT or TN systems. If the system leakage capacitance ahead of the measuring clamp is sufficiently high, the EDS195P can also be used for measurements in single and three-phase IT systems. The suitability of the device is to be checked in the specific case.

## 4. Considerations prior to use

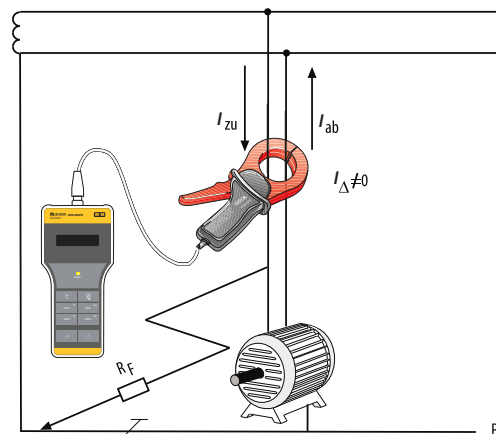
### 4.1 How does the equipment for insulation fault location work

The equipment comprises a locating current injector PGH18... and an insulation fault locator EDS195PM with measuring clamp PSA3... connected.

#### Functional sequence

- Insulation fault location is started by activating the locating current injector PGH18...
- The locating current injector PGH18... briefly connects the live conductors to earth with current limiting.
- The insulation fault creates a closed circuit in which a locating current  $I_L$  dependent on the system voltage flows. The locating current is limited to a maximum value of 25 mA or 10 mA (PGH185/186), 2.5 mA or 1 mA (PGH183).
- The locating current flows from the locating current injector via the live cables, the insulation fault  $R_F$  and the earth cable (PE cable) back to the locating current injector.
- The locating current signal can be measured using measuring clamp placed around the cables in the outgoing circuit from the distribution system and evaluated by the insulation fault locator EDS195PM.
- The location of the fault can be determined exactly by moving along the cable with the measuring clamp.



Abb. 4.1: EDS operating principle

## 4.2 Requirements for reliable insulation fault location

The insulation fault locator has the task of locating the insulation fault  $R_{F-N}$  downstream of the measuring clamp. For this purpose, it must reliably detect the locating current caused by the insulation fault.

Requirements:

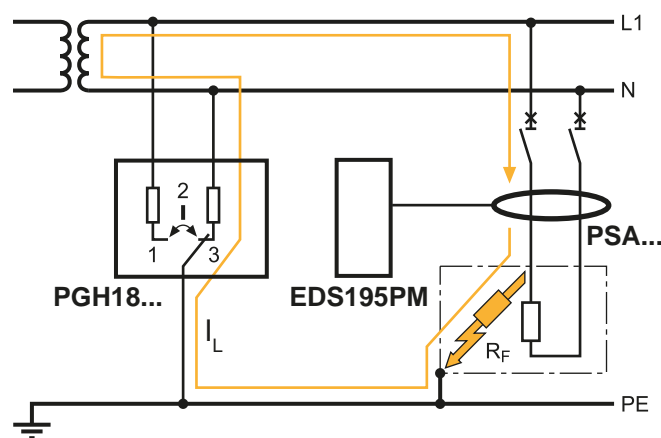
- The insulation fault must be present for at least 30 s
- The locating current is in the following ranges:
  - Main circuits with EDS3090, EDS3090PG, EDS3090PG-13, EDS3092PG, EDS3096PG-13, EDS3096PV, EDS3096PG:  $I_L = 2 \dots 50 \text{ mA}$
  - Control circuits with EDS3091, EDS3091PG, EDS3091PG-13, EDS3092PG:  $I_L = 0.2 \dots 5 \text{ mA}$
- The upstream capacitances  $C_{E-V}$  must be at least as large as the downstream capacitances  $C_{E-N}$ . See also "chapter 3.3.4"
- The total system leakage capacitance must not exceed the maximum values in the characteristics in "chapter 4.4".
- The sum of the locating current and residual current flowing through the measuring clamp or the measuring current transformer must not exceed the following values:
  - Main circuits with EDS3090, EDS3090PG, EDS3090PG-13, EDS3092PG, EDS3096PG-13, EDS3096PV, EDS3096PG: maximum 10 A
  - Control circuits with EDS3091, EDS3091PG, EDS3091PG-13, EDS3092PG: maximum 1 A
- There must be no connections to other outgoing circuits downstream of a measuring clamp or measuring current transformer, see sketch.



Abb. 4.2: Connections between outgoing circuits will result in measuring errors

- As well as the magnitude of the residual current, the frequency of the residual current also affects the reliable detection of the locating current. Residual currents at frequencies other than the system frequency may, e.g., be caused by the usage of frequency converters. The behaviour of the EDS309... is described by the fault curve shown below:
  - If the residual currents measured in **main circuits** exceed 10 A, the EDS195PM outputs the alarm message " $I_{\Delta n} > 10 \text{ A}$ ".  
This statement applies to the system frequencies 50/60/400 Hz for the EDS3090, EDS3090PG, EDS3090PG-13, EDS3092PG, EDS3096PG-13, EDS3096PV and EDS3096PG.
  - If the residual currents measured in **control circuits** exceed 1 A, the EDS195PM outputs the alarm message " $I_{\Delta n} > 1 \text{ A}$ ".  
This statement applies to the system frequencies 50/60/400 Hz for the EDS3091, EDS3091PG, EDS3091PG-13 and EDS3092PG.



Abb. 4.3: Fault curve:  
 A residual current of 2 A at 10 Hz is outside the permitted frequency range (red dot) ==> a valid measurement is not possible!

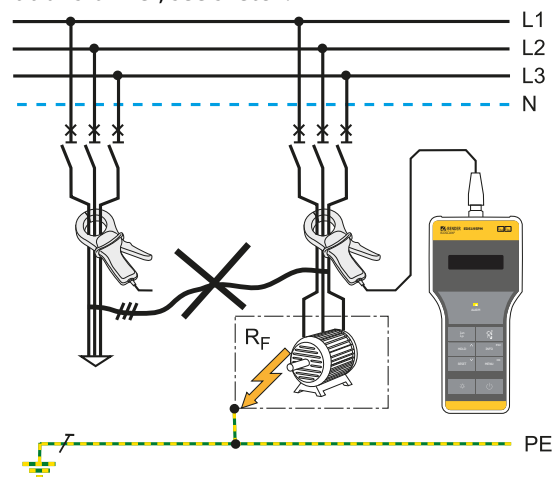

There must be no connections between outgoing circuits downstream of the measuring clamp because such connections will produce interfering residual currents. For example, the message " $I_{\Delta n} > 10A$ " may be output as a consequence.

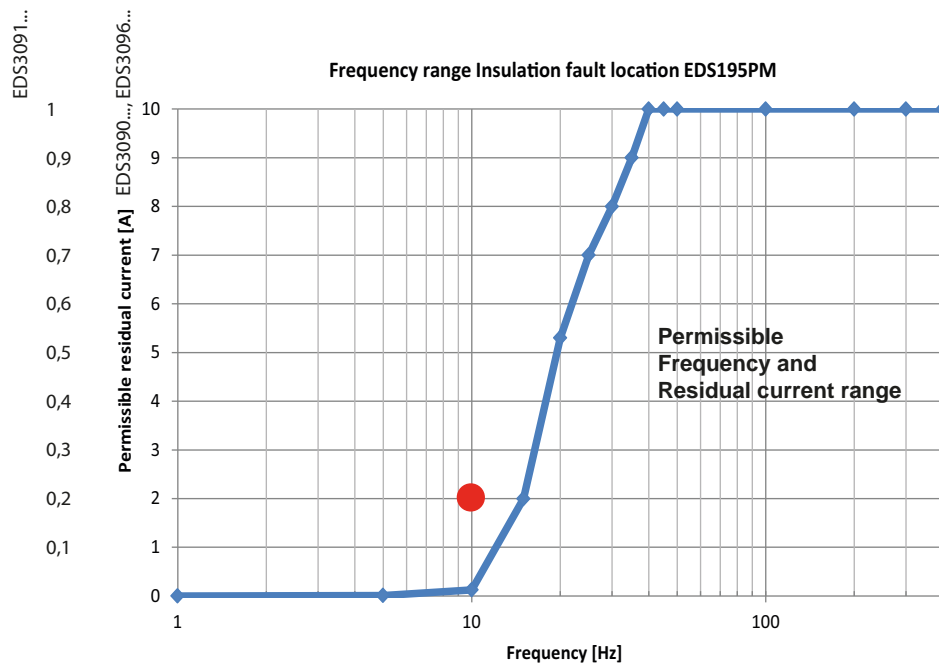

Symmetrical insulation faults downstream of the measuring current transformer will not be detected in certain circumstances. Low frequency residual currents (e.g. caused by converters) can mean that insulation faults are not found if their frequency is the same as or approximately the same as the frequency of the locating cycle of the PGH18....



Parallel cables routed to the same load are to be routed together through the measuring clamp during the measurement.

### 4.3 Reduced locating current

Particularly in DC control voltage systems in the power station and public utility sector there may be relays or PLCs installed that switch at relatively low currents. In such a case the  $I_{\max}$  switch on the PGH18... must be placed in the 10 mA or 1 mA position. The switch's label, e.g. 10 mA or 25 mA, defines the magnitude of the locating current only for DC systems. For AC locating currents see "chapter 4.4".

It must also be checked prior to a measurement with reduced locating current (switch position 10 mA or 1 mA) whether sensitive system components could be triggered unintentionally.

### 4.4 Response sensitivity characteristics of the EDS195PM

The type of system, system voltage, system frequency, system leakage capacitance and locating current all affect the EDS system's response sensitivity. The magnitude of the locating current can be set on the locating current injector PGH18.... A reduced locating current is produced in AC systems depending on the type of system. In comparison to DC systems the related factor in AC systems is 0.5 and in 3AC systems 0.67. For this reason set the response value on the EDS195PM for usage in AC and 3AC systems as follows:

Settings	Main circuit	Control circuit	PV system
Equipment for insulation fault location	EDS3090 EDS3090PG EDS3090PG-13 EDS3092PG EDS3096PG	EDS3091 EDS3091PG EDS3091PG-13 EDS3092PG	EDS3096PV
EDS195PM setting: select the measuring clamp type using button	PSA3020, PSA3052, PSA3165 Measuring range 2...50 mA	PSA3320, PSA3352 Measuring range 0,2...5 mA	PSA3052 Measuring range 2...50 mA
PGH18... setting: locating current $I_L$	25 mA (PGH185/186)	2,5 mA (PGH183)	25 mA (PGH186)
Response range EDS195PM Menu item 2.2: I $\Delta$ L ALM	2...10 mA	0,2...1 mA	2...10 mA
PGH18... setting: reduced locating current $I_L$	10 mA (PGH185/186)	1 mA (PGH183)	10 mA (PGH186)
Response range EDS195PM with reduced locating current Menu item 2.2: I $\Delta$ L ALM	2...5 mA	0,2...0,5 mA	2...5 mA

Tab. 4.1: Settings for the EDS195PM and the PGH18...

For the response value setting see menu item "2. Settings/ 2. I $\Delta$ L) on page 42. The response values are given as characteristics that can have a maximum error of  $\pm 30\%$ . Measuring clamp tolerances are included here. The characteristics apply at the related nominal voltage stated.

In case of variation in the nominal voltage, a proportional change in the response values is to be expected. In case of system voltages that change dynamically or in case of superimposed DC currents and AC currents that vary from the system frequency (e.g. due to frequency converters), response values outside the ranges shown may result.



The characteristics below enable you to simply determine a practical response value for the EDS195PM. If the insulation monitoring device in a monitored system indicates an alarm message, manual insulation fault location can be started. Proceed as follows:

1. Select the characteristics (3AC, AC, DC) that are appropriate for your type of system.
2. From these, select the diagram that best matches the desired system voltage.
3. Calculate the expected leakage capacitance  $C_e$  of the system monitored. Insulation monitoring devices in the IRDH... series can indicate the magnitude of the leakage capacitance (press INFO button). Apply this value to the diagram in the form of a vertical line. If it is not possible to check the capacitance, the highest capacitance in the related diagram is to be taken.
4. The characteristics shown indicate the response sensitivity of the EDS195PM in main circuits for 2 mA, 5 mA and 10 mA and in control circuits for 0.2 mA, 0.5 mA and 1 mA. Values above the related curve cannot be measured. Values and characteristics that lie in the area between the upper and lower characteristic can be estimated approximately using the existing characteristics.
5. Set the required response value, on the left of the line from point 3., on the EDS195PM.
6. The characteristics for DC 24 V and AC 42 V do not apply to the EDS3096, as the locating current generator operates with a locating voltage of DC 50 V. For this reason the curves for DC 60 V and AC 110 V apply at these nominal voltages.

#### 4.4.1 Response characteristics for main circuits in 3AC systems



Bei der Anwendung des CTAF-SET gilt nur die Kennlinie für 10 mA!

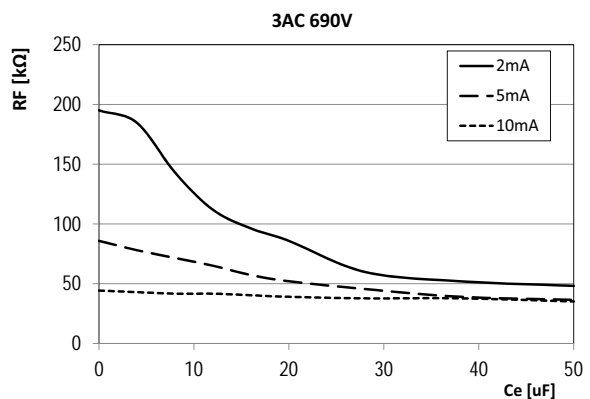
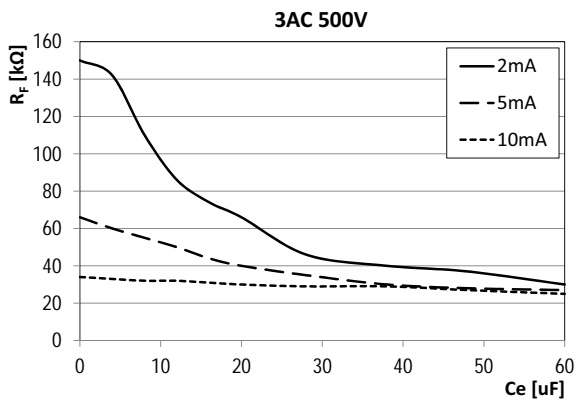
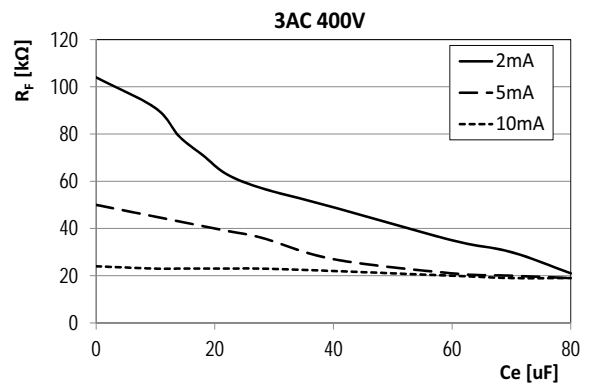
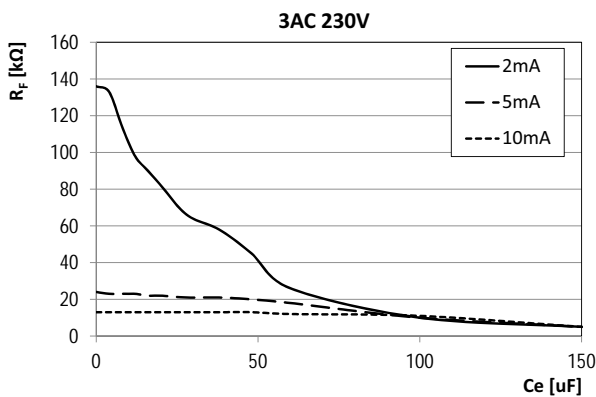

### 4.4.2 Response characteristics for main circuits in AC systems

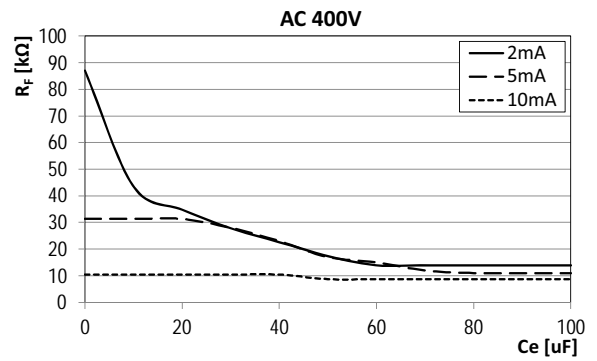
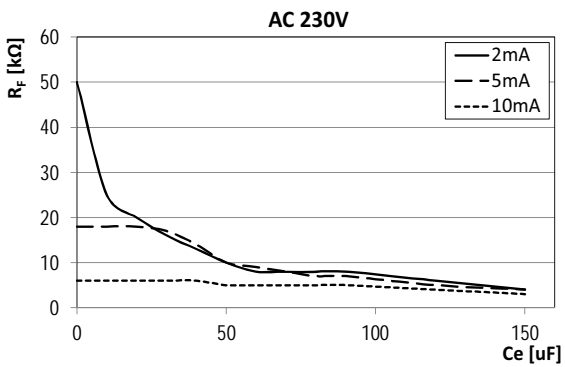
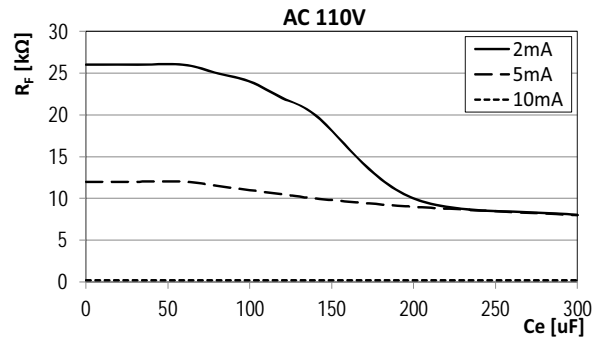
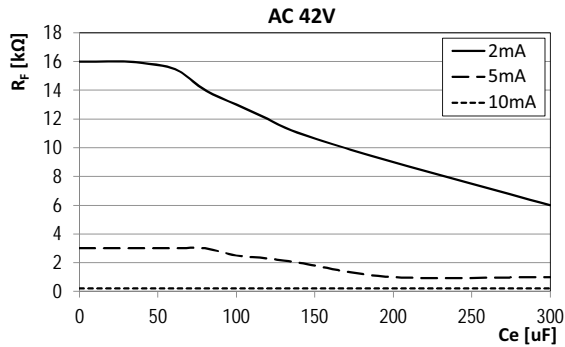

### 4.4.3 Response characteristics for main circuits in DC systems

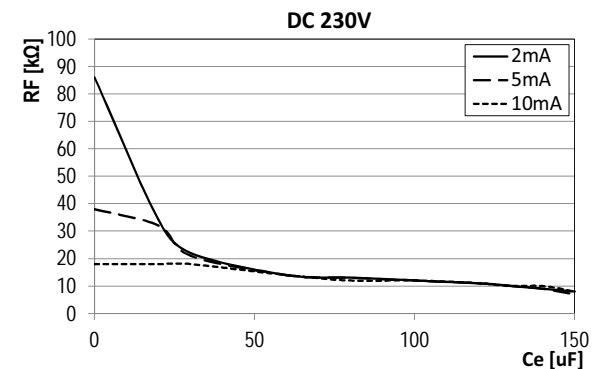
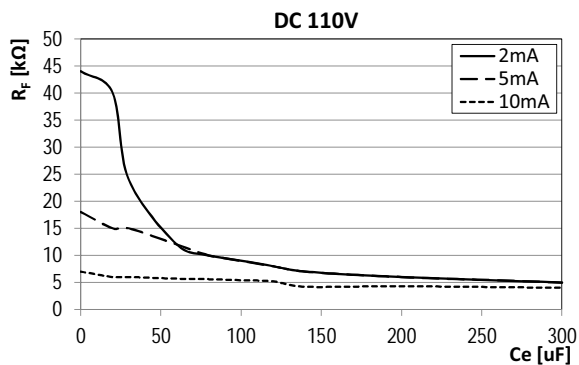
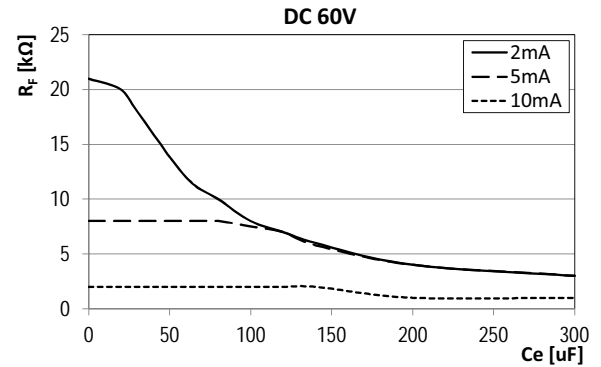
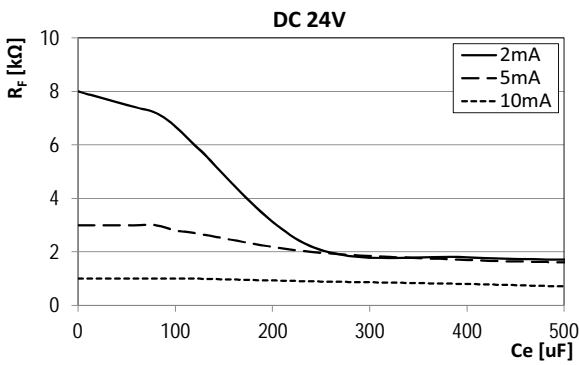

#### 4.4.4 Response characteristics for control circuits in AC systems

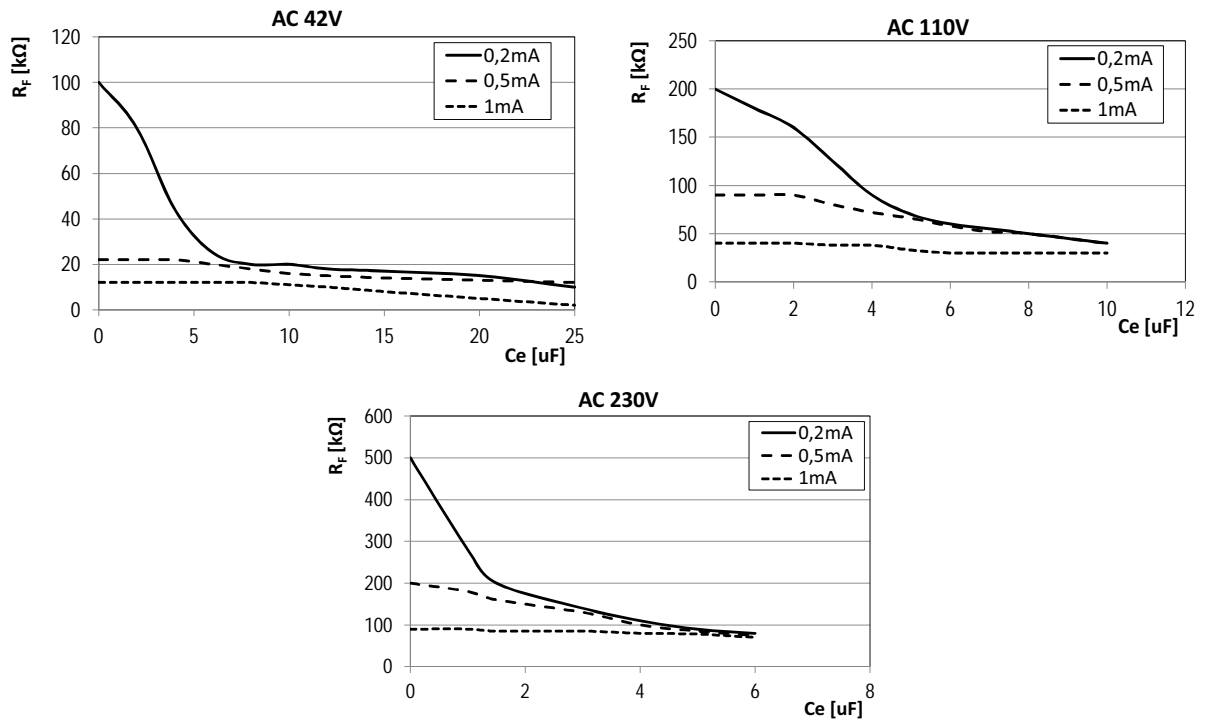

#### 4.4.5 Response characteristics for control circuits in DC systems

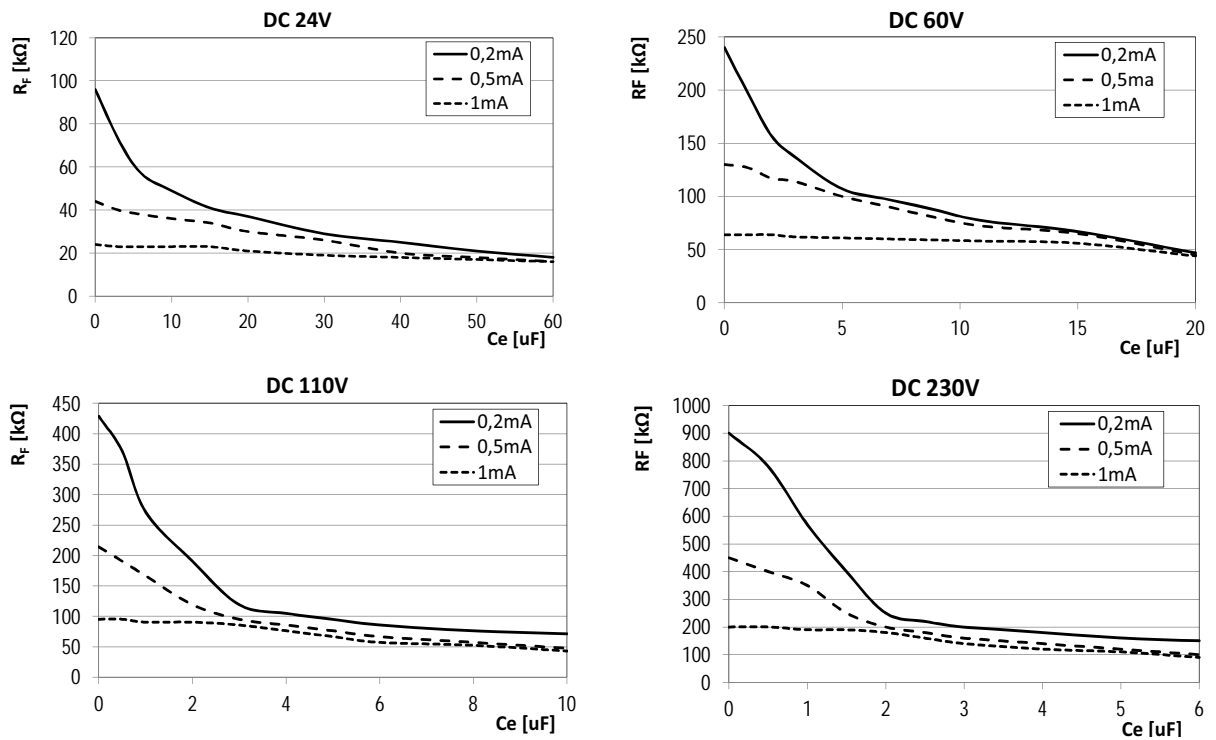

## 5. Connecting the locating current injector



### **Hazard due to excessively high locating voltage!**

Check the information on the nameplate to ensure the devices to be connected are suitable for the supplying system. The operation of the PGH18... and possibly the power supply unit with an incorrect supply voltage can cause irreparable damage to the devices.



Prior to commissioning check whether all system components are correctly connected together.

### 5.1 Disconnecting insulation monitoring device

During insulation fault location using the EDS309... an existing insulation monitoring device must be disconnected from the system for the duration of the fault location if its internal resistance is  $R_i < 120 \text{ k}\Omega$ . During this process the connection to the system must be interrupted on all poles, shutting down the supply voltage to the insulation monitoring device is insufficient. On the usage of such a device with  $R_i \geq 120 \text{ k}\Omega$  the effect is negligible, disconnection is not required in this case. However the PGH18... will affect the measurement made by the insulation monitoring device.

### 5.2 Locating current injector in an electrically isolated IT system

For insulation fault location in electrically isolated systems using the EDS3096PG, the integrated voltage source G in the PGH186 supplies a locating voltage.

The locating voltage DC 50 V is provided by the PGH186 at the socket L1(+). Make sure that this socket is coupled to the system to be monitored during insulation fault location, only then will the integrated voltage source in the PGH186 be effective.



Note that the active conductors in the system to be checked must be coupled together via loads or the electrically isolated power supply.

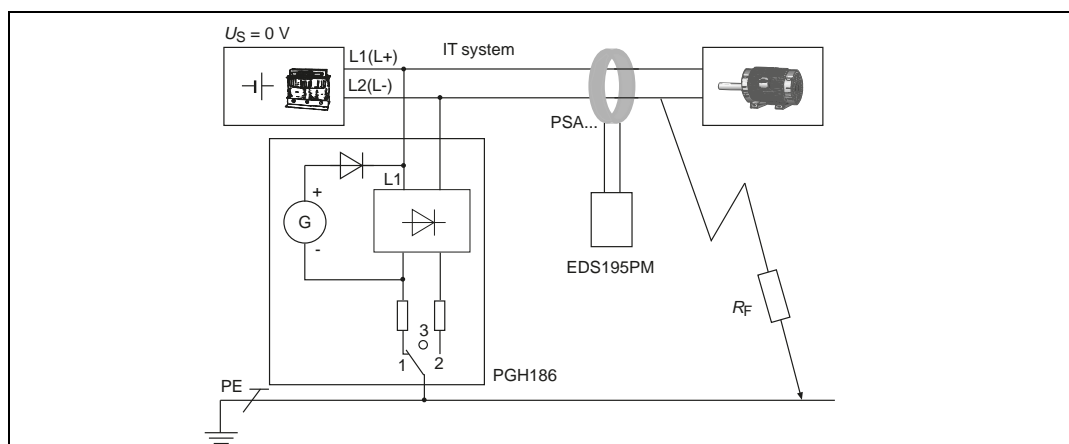

### 5.3 Connection to a live IT system



**Risk of electric shock!**

On touching live uninsulated conductors, death or serious injury may be caused. For this reason prevent any physical contact with active conductors and follow the rules for working on electrical systems.



**Risk of electric shock!**

If the PGH18... is connected using terminals L1, L2, L3 (or L1, L2) to a system that is live due to its operation, the terminal  $\perp$  must not be disconnected from the protective earth conductor (PE). Otherwise the terminal will be at the dangerous system voltage!

Connect the locating current injector PGH18... as follows:

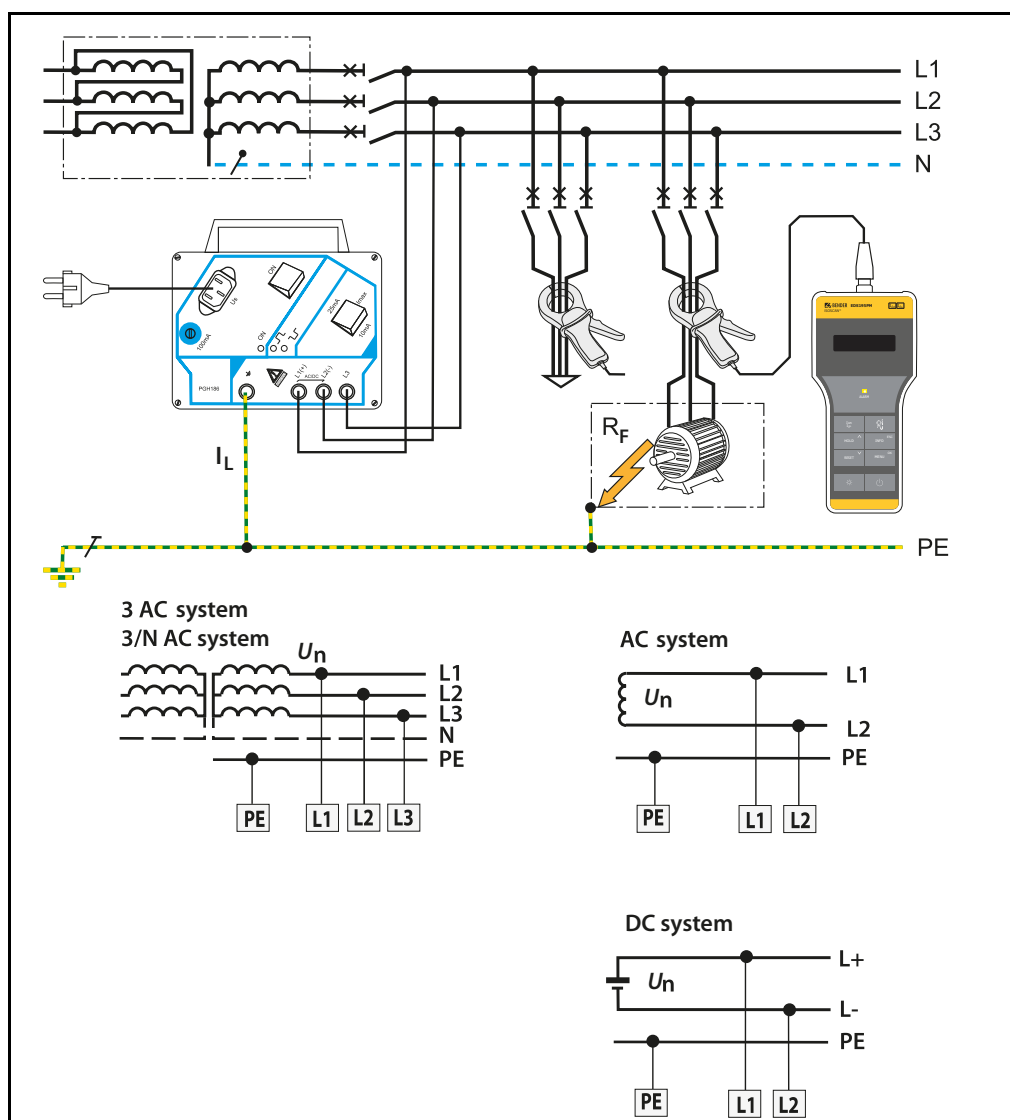

## 5.4 Connection to a PV system



**Risk of electric shock!**

On touching live uninsulated conductors, death or serious injury may be caused. For this reason prevent any physical contact with active conductors and follow the rules for working on electrical systems.



**Risk of electric shock!**

If the PGH186 is connected using terminals L1(+) and L2(-) to a system that is live due to its operation, the terminal  $\perp$  must not be disconnected from the protective earth conductor (PE). Otherwise the terminal will be at the dangerous system voltage!



**Risk of short circuit!**

When the EDS3090PV is connected with test leads without integrated fuses a short circuit may occur due to incorrect wiring. Connect the EDS3090PV with the accompanying test lead with integrated fuses to reduce the risk of a short circuit.

Connect the locating current injector PGH186 as follows:

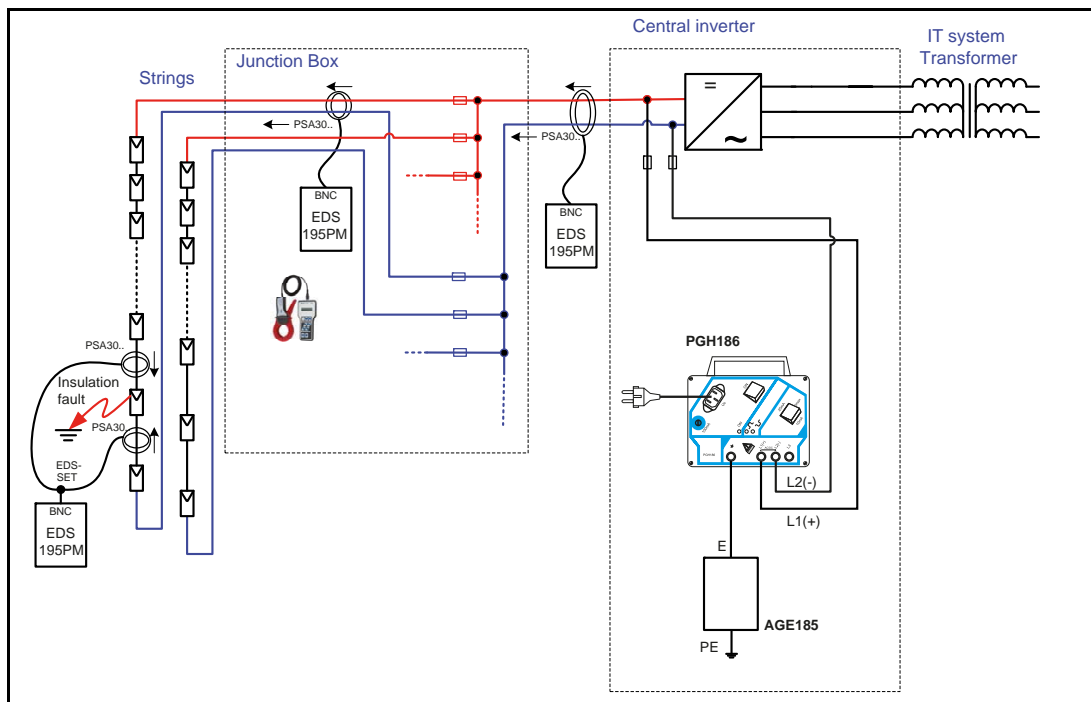

**Legend:**

- PGH186                      Locating current injector
- AGE185                      Coupling device
- EDS3096PV                Equipment for insulation fault location
- EDS195PM                Insulation fault locator
- PSA30..                    Measuring clamp (locating current sensor)
- EDS-SET                    BNC Tee connector and 2 BNC cables for fault localisation in diode-decoupled systems

For insulation fault location within the junction box, it is essential that the  $\pm$  cables of a string are arranged in a way that the measuring clamp PSA30... can be put around the cables. Insulation faults in the strings can be localised by means of two measuring clamps connected in parallel and an EDS-SET. For this purpose, place the measuring clamps on both sides of the module supply conductors in the direction indicated by the arrows.

## 6. Operation

### 6.1 Short description of insulation fault location (EDS mode)

**Risk of electric shock!**



*On touching live uninsulated conductors, death or serious injury may be caused. For this reason avoid any contact whatsoever with active conductors on positioning the measuring clamp.*

#### 6.1.1 Commissioning the PGH18... for locating current injection

1. The PGH18... is to be connected first to PE in the system to be checked, see page 30
2. Then connect the PGH18... to the active conductors
3. Connect device to  $U_5$  and switch on

If the locating current  $I_L$  is to be supplied by an IRDH575, iso685-x-P or isoxx1685xP, select the EDS-Setup menu item "Use Portable EDS - on".

#### 6.1.2 Insulation fault location using EDS195PM

1. There must be no conductors in the measuring clamp and the measuring clamp must be stationary during commissioning
2. Switch on EDS195PM without current transformer using the  button
3. Wait for the end of the self test and the message "No CT connected"
4. Set required current transformer type using the  button
5. Connect selected current transformer and wait for end of the self-test
6. Fit measuring clamp to PE conductor between PGH18... (IRDH575, iso685-x-P or isoxx1685xP) and, for example, PE rail to demonstrate that the necessary locating current  $I_L$  is flowing.
7. Place measuring clamp around the associated active conductors for the related outgoing circuit. Caution! Do **not** include PE in the cables in the clamp!
8. Read measured value and evaluate.  
If the response value set has been exceeded, the "ALARM" LED flashes.

### 6.2 Detailed description of insulation fault location

- For information on using the EDS309... without a permanently installed EDS system, see page 45
- For information on using the EDS309... in addition to a permanently installed EDS system, see page 48
- For information on using the EDS309... in diode-decoupled DC systems, see page 52



### 6.3 Description of a residual current measurement

Using the EDS195PM it is also possible to undertake residual current measurements up to a value of 10 A, see page 52.



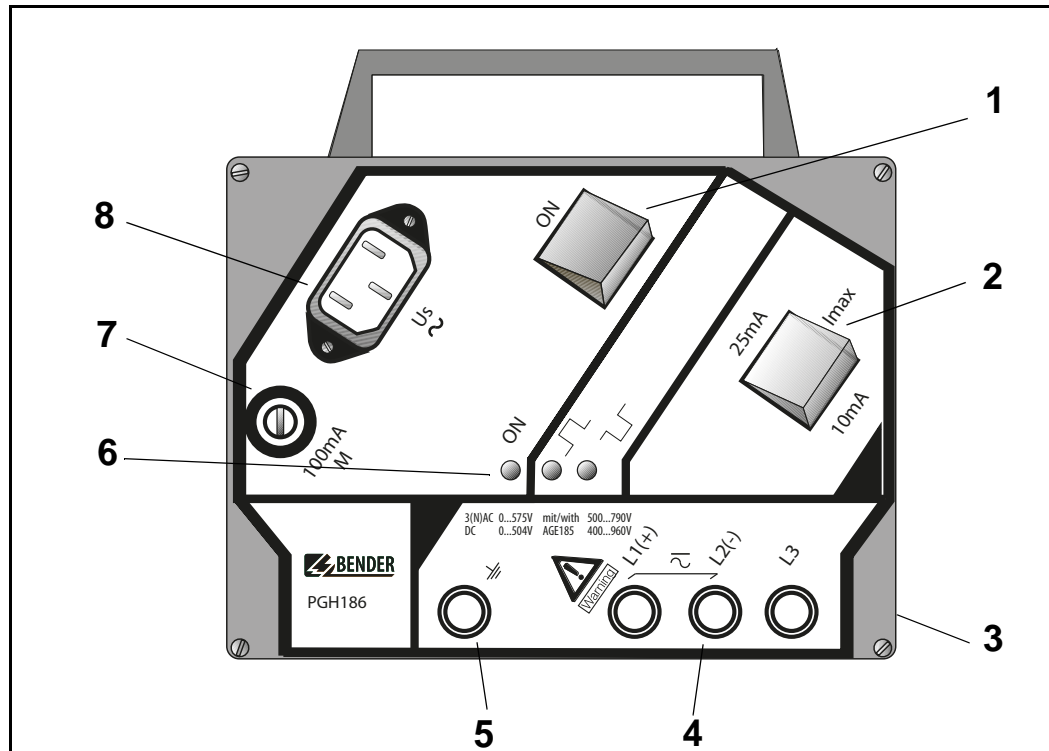

## 6.4 Displays and controls on the PGH18...

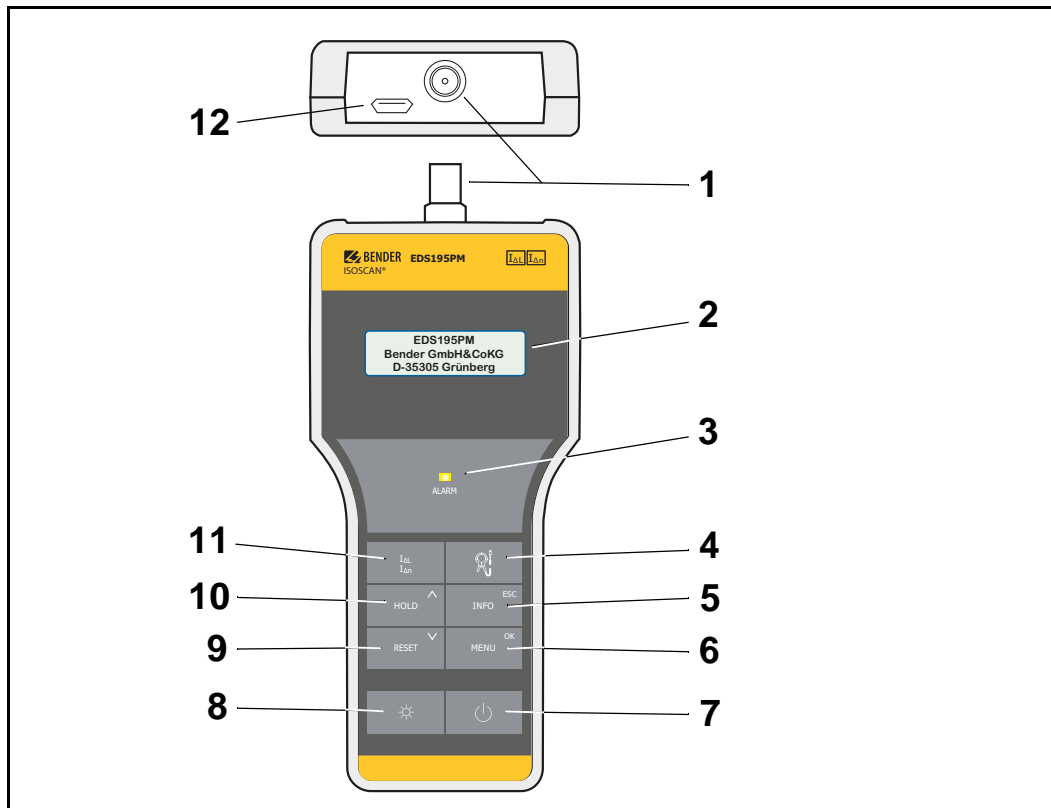

1	ON/OFF switch, switch on or off locating current
2	Changeover switch for maximum locating current values: 25/10 mA or 2.5/1 mA
3	Not shown: magnetic strip on rear of housing for fastening to metal items (e.g. switch cabinet)
4	3 sockets for coupling to system
5	Socket for PE connection
6	Indicator LEDs: ON Operation LED  Indication of positive locating current cycle  Indication of negative locating current cycle
7	Fine-wire fuse 100 mA
8	Flush mounted connector for supply voltage

## 6.5 Displays and controls on the EDS195PM



1		BNC connection for measuring clamp
2		LC display, illuminated 3 lines of 16 characters
3		ALARM LED: - Flashes if the response value is exceeded - Illuminates continuously on rectification of the fault, if the fault memory is activated
4		Button for selecting the current transformer: - <b>PSA30xx</b> = PSA30... / PSA3165 (suitable for $I_{Lmax} = 50 \text{ mA}$ ) - <b>CTAF-SET</b> (suitable for $I_{Lmax} = 50 \text{ mA}$ , $I_{Lmin} = 25 \text{ mA}$ ) - <b>W/WR/WS</b> = W.... / WR.... / WS.... (suitable for $I_{Lmax} = 50 \text{ mA}$ ) - <b>PSA33xx</b> = PSA33... (suitable for $I_{Lmax} = 5 \text{ mA}$ ) - <b>W/WS-8000</b> = W....-8000 / WS....-8000 (suitable for $I_{Lmax} = 5 \text{ mA}$ ) - <b>WF</b> = WF... (only suitable for $I_{\Delta n}$ )
5	 ESC	INFO button: - Device type, date, time, manufacturer - Software version - Actual response values $I_{\Delta L}$ and $I_{\Delta n}$ - Status word (setup status) ESC button: Leave a menu function without changing parameters

6		MENU button: Open the menu Enter button: Accept modified parameter values or selected menu items
7		On/Off button
8		Button for switching on/off the display lighting
9		RESET button: delete fault memory Down button: move down in the menu, reduce parameter values
10		HOLD button: save the measured value Up button: move up in the menu, increase parameter values
11		Button for selecting the operating mode: $I_{\Delta L}$ = Insulation fault location in IT systems (EDS mode) $I_{\Delta n}$ = Residual current measurement in TN-S systems (RCM mode)
12		Micro USB connection for charging the device's rechargeable battery

## 6.6 Operating the EDS195PM

### 6.6.1 Switching on and off the device

1. Switch on the device without current transformer using On/Off button.  
The self-test is started after switching on.  
If the self-test is completed normally "No CT connected" appears.
2. You can switch off the device by pressing the On-Off button for around 2 s.





Abb. 6.1: Start sequence for the EDS195PM

### 6.6.2 Changing the measuring clamp

Two methods can be used to change the measuring clamp.

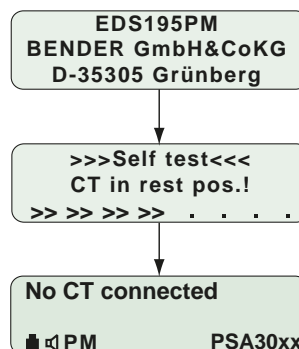
- Changing with EDS195PM switched off:
  - Disconnect clamp no longer required
  - Switch on EDS195PM
  - Wait for "No CT connected" message
  - Set required clamp type
  - Connect related clamp
  - Wait for end of self-test.
  
- Changing with the EDS195PM in operation:
  - Disconnect clamp from the device
  - Wait for "No CT connected" message
  - Set required clamp type
  - Connect related clamp
  - Wait for end of self-test.

### 6.6.3 Improved legibility due to display lighting

Press the  button at the bottom left to improve the legibility of text and symbols. Switch off the lighting by pressing the button again.

### 6.6.4 Changing between insulation fault location $I_{\Delta L}$ and residual current measurement $I_{\Delta n}$ operating modes

Here you can select the measuring function.  $I_{\Delta n}$  for residual current measurement preferably in TN/TT systems.  $I_{\Delta L}$  for insulation fault location in IT systems. Avoid changing the mode during insulation fault location.

### 6.6.5 Quickly checking the response values for $I_{\Delta L}$ and $I_{\Delta n}$

Press the INFO button three times to display the actual response values.

### 6.6.6 Checking Info menu

The following information appears on the display in succession on pressing the INFO button:

- Device name, time, date and manufacturer
- Software version with date
- Actual response values  $I_{\Delta L}$  and  $I_{\Delta n}$
- Status information, coded, see page 61

### 6.6.7 Significance of the display elements

The elements shown relate to the EDS mode ( $I_{\Delta L}$ ). This mode is used for insulation fault location.

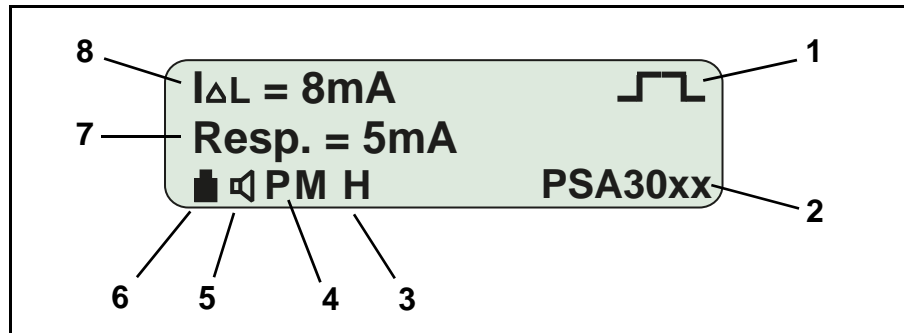

1	<p>Indication of the locating current pulse:</p> <p>  = Positive pulse,   = Pause or no measurement possible when permanently displayed   = Negative pulse   29 = Timer (29...0) shows the duration of a measurement of an outgoing circuit                 </p>
2	<p>Indication of the selected transformer type:</p> <ul style="list-style-type: none"> <li>- <b>PSA30xx</b> = PSA30... / PSA3165 (suitable for <math>I_{Lmax} = 50</math> mA)</li> <li>- <b>CTAF-SET</b> (suitable for <math>I_{Lmax} = 50</math> mA <math>I_{Lmin} = 25</math> mA)</li> <li>- <b>W/WR/WS</b> = W... / WR... / WS... (suitable for <math>I_{Lmax} = 50</math> mA)</li> <li>- <b>PSA33xx</b> = PSA33... (suitable for <math>I_{Lmax} = 5</math> mA)</li> <li>- <b>W/WS-8000</b> = W...-8000 / WS...-8000 (suitable for <math>I_{Lmax} = 5</math> mA)</li> <li>- <b>WF</b> = WF... (only suitable for <math>I_{\Delta n}</math>)</li> </ul>
3	H = Hold function is activated; measured value indication "frozen"
4	M = Fault memory is activated
5	Loudspeaker symbol visible: The presence of an alarm is also output audibly
6	Charge state of the rechargeable battery in the steps 0%, 33%, 66%, 100%
7	Resp. = Response value $I_{\Delta L}$
8	$I_{\Delta L}$ = Indication of the actual locating current measured

## 6.7 Standard displays on the EDS195PM

### 6.7.1 EDS measurement ( $I_{\Delta L}$ )

#### 6.7.1.1 Standard display if there is no cable to be measured in the clamp

The device is in the EDS mode ( $I_{\Delta L}$ ).

A measured locating current  $I_{\Delta L}$  is not indicated, as there is no conductor in the measuring clamp. The display shows the timer count (29...0).

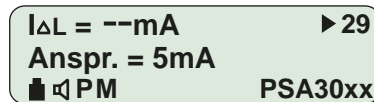

#### 6.7.1.2 Standard display for EDS measurement ( $I_{\Delta L}$ ) with cable in the clamp

The display is indicating a measured fault current  $I_{\Delta L}$  of 3 mA. A measurement in progress is indicated by the change in the polarity of the measuring pulse () with a pause (- - -) in between.

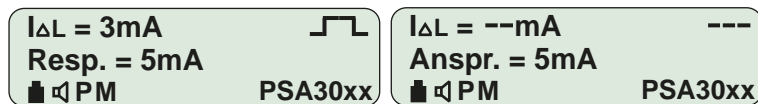

Note that only half the magnitude of the locating current  $I_L$  generated by the PGH18... in AC systems is indicated by EDS195PM. The half-wave rectification used in the PGH18... reduces the value indicated in AC systems to 50 %, in 3AC systems to 67 %.

#### 6.7.1.3 Standard display for measuring faults or pauses between changes in polarity of the measuring pulse

When no measurement is possible due to low frequency residual currents or because the measuring clamp is not being held still, the display permanently indicates a pause (- - -) at the top right corner. During the evaluation of the measurement the display indicates a pause (- - -) for a short time only.

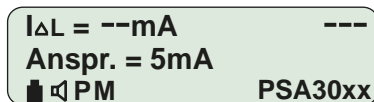

### 6.7.2 RCM measurement ( $I_{\Delta n}$ )

#### 6.7.2.1 Standard display for RCM measurement ( $I_{\Delta n}$ ) with cable in the clamp

The display is indicating the measured residual current  $I_{\Delta n}$  of 16 mA. The residual current response value set is 100 mA.

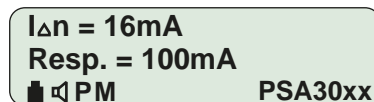

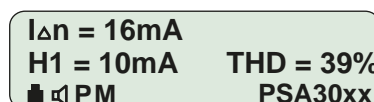

The following display appears if menu item "2.Settings/7.Harmonics: on" is activated. This setting can only be used for 50 Hz or 60 Hz systems.

For the 1st harmonic (fundamental) the display is indicating a measured current of 10 mA as well as a total harmonic distortion THD of 39 %.



## 6.8 Alarms during EDS measurement or RCM measurement

If one of the response values set  $I_{\Delta L}$  or  $I_{\Delta n}$  is exceeded, the ALARM LED flashes. If the fault memory M is activated, the ALARM LED continues to illuminate after the removal of the fault. The alarm saved is cleared using the RESET button.

<p><math>I_{\Delta L} = 8\text{mA}</math> Resp. = 5mA PM PSA30xx</p> 		<p>Alarm during insulation fault location (EDS): LED flashes</p>
<p><math>I_{\Delta n} = 1.6\text{A}</math> Resp. = 100mA PM PSA30xx</p>		<p>Alarm during a residual current measurement (RCM): LED flashes</p>

## 6.9 Indication of device and measuring errors

The following table explains the error messages that may occur.

<p><b>Self test error</b> PRESS -&gt;RESET PM PSA30xx</p>	<p>Can only occur after the end of the self-test:</p> <ul style="list-style-type: none"> <li>- Incorrect current transformer type set</li> <li>- During the self-test the clamp was: Not stationary Or a residual current was flowing through it Or the PGH locating current was flowing through it</li> <li>- EDS195PM hardware faulty</li> </ul> <p>Press the "RESET" button to restart a self test.</p>
<p><b>No CT connected</b> PM PSA30xx</p>	<p>No measuring clamp or no measuring current transformer on the measuring input or incorrect transformer type connected</p> <p>Measures: Connect correct measuring clamp or correct measuring current transformer</p>
<p><math>I_{\Delta L} = \text{--mA}</math> --- Anspr. = 5mA PM PSA30xx</p>	<p>A permanent display of pause (---) indicates no measurement is possible.</p> <p>Steps:</p> <ul style="list-style-type: none"> <li>- Hold the measuring clamp still</li> <li>- Avoid low frequency residual currents</li> </ul>
<p><b>Error <math>I_{\Delta L}</math></b> PM PSA30xx</p>	<p>A malfunction has occurred during insulation fault location</p> <p>Possible causes:</p> <ul style="list-style-type: none"> <li>- The measuring clamp was not held still.</li> <li>- There is a low frequency residual current flowing through the measuring clamp that is interfering with the EDS measurement</li> <li>- There a magnetic field around the measuring clamp that is interfering with the EDS measurement</li> <li>- EDS195PM hardware faulty</li> </ul>



*If the EDS195 can no longer detect the locating current due to system interference and an existing alarm is therefore cleared, an insulation fault will be detected again at the end of the interference.*

## 6.10 Factory settings EDS195PM (state as supplied)

Most of the settings are made on the menu. If this is not the case, the setting is marked with (button).

Operating mode (button):	I $\Delta$ L (EDS mode = insulation fault location)
Current transformer (button):	Measuring clamp PSA3052 (for EDS3090 and 3096) Measuring clamp PSA3352 (for EDS3091)
Illumination (button):	Off
Fault memory:	On
Buzzer:	On
Response value $I_{\Delta L}$ with PSA30...:	5 mA
Response value $I_{\Delta L}$ with PSA33...:	0.5 mA
Response value $I_{\Delta n}$ :	100 mA
System frequency $I_{\Delta n}$ :	50 Hz
Measurement of harmonics $I_{\Delta n}$ :	Off
User interface language:	English
Time:	CET







## 6.11 Menu structure

The menu structure is shown schematically in the following.

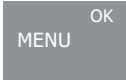
Level 1	Level 2	Level 3 or explanation
1. Exit		
2. Settings	1. Exit 2. I $\Delta$ L ALM: 0.2...10 mA 3. I $\Delta$ n ALM: 10 mA...10 A 4. Memory: on/off 5. Buzzer: on/off 6. Frequ.: 50/60Hz/up to 1kHz 7. Harmonics: on/off	Response value measured locating current I $\Delta$ L Response value residual current I $\Delta$ n  Audible alarm Frequency of the system monitored Indication of harmonics and total harmonic distortion THD in %
3. System	1. Exit  2. Language  3. Clock  4. Contrast: 0...15	1. Exit 2. German 3. English 4. French 5. Russian  1. Exit 2. Format: D.M.Y 3. Date 4. Time  Contrast setting for display
4. Harmonics	1. Exit 2. H1 < 10 mA 3. H2 < 10 mA ..... 9. H8 < 10 mA	This menu item is used only for the indication of harmonics from H1 to H8. To display the harmonic with the greatest amplitude in the standard display with the menu closed, the menu item "7. Harmonics: on/off" on the Settings menu is to be activated
5. I $\Delta$ L alarms	1. Exit 2. Entries 3. Delete	Alarm No. 001 No. 002 No. ....  1. Exit 2. Delete Data
6. I $\Delta$ n logger	1. Exit 2. Entries 3. Change: 10...100 % 4. Overwrite: yes/no 5. Delete	Entry No. 001 No. 002 No. ....  Percentage change from which logging becomes active  Overwrite oldest data record  1. Exit 2. Delete Data
7. Service		For service only

### 6.11.1 Navigating in the menu

<ul style="list-style-type: none"> <li>- Open the menu using MENU</li> <li>- Select a menu item or accept a value using OK</li> </ul>	
<ul style="list-style-type: none"> <li>- Navigate up or down in the menu</li> <li>- Increase or reduce values</li> </ul>	 
<p>ESC:</p> <ul style="list-style-type: none"> <li>- Return from the last menu item selected</li> <li>- Discard modified setting without saving</li> </ul>	

### 6.11.2 Menu item: Settings

Using this menu item you can access the following parameters for the insulation fault location and for the residual current measurement to:

- Set the response value for the locating current  $I_{\Delta L}$  measured with the measuring clamp to between 0.2...10 mA.  
This value range is equally suitable for control circuits (0.2...1 mA) and main circuits (2...10 mA). On the usage of the locating current injector note that the permissible locating current defined for control circuits is  $I_{Lmax} = 5$  mA, while for main circuits it is  $I_{Lmax} = 50$  mA.
- Set the response value for the residual current  $I_{\Delta n}$  measured with the measuring clamp to between 10 mA and 10 A
- Activate or deactivate the fault memory
- Activate or deactivate audible signalling of alarms
- Set the frequency of the system monitored
- Enable the indication of the harmonics to display the current for the harmonic with the greatest amplitude in the standard display. All harmonics from H1 to H8 can be checked using menu item "4. Harmonics", see also page 44. Note that with harmonics activated only system frequencies of 50 Hz and 60 Hz can be selected.

Level 1	Level 2	Meaning
2. Settings	1. Exit 2. $I_{\Delta L}$ ALM: 0.2...10 mA 3. $I_{\Delta n}$ ALM: 10 mA...10 A 4. Memory: on/off 5. Buzzer: on/off 6. Frequ.: 50/60Hz/up to 1kHz 7. Harmonics: on/off	<i>Response value measured locating current <math>I_{\Delta L}</math></i> <i>Response value residual current <math>I_{\Delta n}</math></i>  <i>Audible alarm</i> <i>Frequency of the system monitored</i> <i>Indication or harmonics and total harmonic distortion THD</i>



*Alarms are signalled by the Alarm LED and the buzzer (delivery condition).*

### 6.11.3 Menu item: System

Use this menu item to select the language for the user interface and to set the correct date and time. The date format can be changed.

You can adjust the quality of the display by adjusting the contrast.

Level 1	Level 2	Level 3 or explanation
3. System	1. Exit	
	2. Language	1. Exit 2. German 3. English 4. French 5. Russian
	3. Clock	1. Exit 2. Format: D.M.Y 3. Date 4. Time
	4. Contrast: 0...15	<i>Contrast setting for display</i>

### 6.11.4 Menu item: Harmonics

This menu item is used only for the indication of harmonics from H1 to H8.

Level 1	Level 2	Meaning
4. Harmonics	1. Exit 2. H1 < 10 mA 3. H2 < 10 mA ..... 9. H8 < 10 mA	<i>This menu item is used only for the indication of harmonics from H1 to H8. To display the harmonics, activate the menu item "2.Setting/7. Harmonics: on/off"</i>

### 6.11.5 Menu item: $I_{\Delta L}$ alarms

Using this menu item you can check the alarms recorded automatically during insulation fault location. The data records are numbered and contain the following information:

- The start of the alarm
- The end of the alarm
- The minimum locating current  $I_{\Delta L}$  measured
- The maximum locating current  $I_{\Delta L}$  measured

A maximum of 300 data records are saved.

The existing data records can be deleted using the menu.

Level 1	Level 2	Level 3	Meaning
5. $I_{\Delta L}$ alarms	1. Exit		
	2. Entries	Alarm No. 001 No. 002 No. ....	<i>Period for the recording and min./max. values measured for <math>I_{\Delta L}</math></i>
		3. Delete	1. Exit 2. Data delete

### 6.11.6 Menu item: $I_{\Delta n}$ logger

Using this menu item you can check the measured values recorded automatically during a residual current measurement. The data records are numbered and contain the following information:

- The start time for the measurement and the change in the residual current monitored
- The residual current  $I_{\Delta n}$  measured

A maximum of 300 data records are saved.

The existing data records can be deleted using the menu.

Level 1	Level 2	Level 3	Meaning
6. $I_{\Delta n}$ logger	1. Exit		
	2. Entries	Entry No. 001 No. 002 No. ....	Time of the recording and residual current $I_{\Delta n}$ measured
	3. Change: 10...100 %		Percentage change from which logging becomes active
	4. Overwrite: yes/no		Overwrite oldest data record
	5. Delete	1. Exit 2. Data delete	

## 6.12 Practical usage

### 6.12.1 Insulation fault location in a system without a permanently installed EDS system









**Risk of electric shock!**

*On touching live uninsulated conductors, death or serious injury may be caused. For this reason avoid any contact whatsoever with active conductors on connecting the PGH and positioning the measuring clamp.*

The EDS309... is primarily used as a portable insulation fault location system in unearthed IT systems. Once all the instructions in chapter "Considerations prior to use" on page 21 have been followed, insulation fault location can be started. Proceed as follows during this process:

1. Check whether the system voltage is within the permissible limits.  
The permissible voltages are stated in the user interface on the PGH18...
2. Connect the locating current injector PGH18... close to the feed, see connection diagram on page 30. During this process follow the general guidelines for working with electrically live systems!
  - First connect the PE socket on the PGH18... to the system's PE using the green-yellow wire.
  - Then connect the PGH18... to the system to be checked using the connection wires provided.

Three-phase system	Connect sockets L1, L2 and L3 to the system
Single-phase AC or DC	Connect sockets L1 and L2 to the system

3. Connect the PGH18... to a suitable power supply using the power cable supplied (see nameplate).
4. If there is an insulation monitoring device with an Ohmic internal resistance  $< 120 \text{ k}\Omega$  in the IT system to be checked, disconnect it from the system to be checked on all poles. It is not sufficient to switch off the power supply to the insulation monitoring device.
5. Set the maximum locating current using the  $I_{\text{max}}$  switch on the PGH18.... Follow the instructions in chapter "Reduced locating current" on page 24.
6. Switch on the PGH18.... The "ON" LED illuminates and the two "" and "" LEDs flash alternately in synchronism with the test cycle. If there is no activity indicated on the LEDs, check the supply voltage and the fine-wire fuse that can be accessed from the front panel.
7. Switch on the EDS195PM without a current transformer connected by pressing the  button. The device undertakes a self-test and outputs the error message "No CT connected" because a current transformer is not connected.
8. Now select the type of measuring clamp or measuring current transformer to be connected using the  button. The device undertakes a further self-test and outputs the error message "No CT connected" because a current transformer is not connected.
9. Then connect the pre-selected measuring clamp or the pre-selected measuring current transformer to the EDS195PM. The device undertakes a further self-test and is then in the EDS mode. " $I_{\Delta L}$ " appears in the first line of the display.
10. On **handling the measuring clamp** note:
  - Do not bring measuring clamp into contact with system voltages above the rated insulation voltage (see nameplate on the measuring clamp with information on measuring category, e.g. CAT III)
  - Always keep contact surfaces on measuring clamp's iron core clean.
  - Do not use measuring clamp in the immediate vicinity of devices that produce magnetic fields such as transformers or chokes and also not near adjacent conductors carrying high currents.
  - Never disconnect measuring clamp from the EDS195PM while it is placed around electrically live conductors. Otherwise the measuring clamp may be irreparably damaged!
  - Aim for the best possible symmetry of the conductors in the measuring clamp. Otherwise the measuring clamp may go into saturation due to an excessively high load current and cause an alarm  $I_{\Delta n} > 10 \text{ A}$ .
  - **Keep the measuring clamp still** during the measurement!
  - During the measurement do not apply any pressure to the clamp limb.
11. Cover the green and yellow lead between PHG18... and earth with the measuring clamp. A measurement process should take no more than 30 seconds. When the EDS195PM is ready to take a measurement, the countdown (29...0) at the top right corner of the display starts. If the time has expired and no error has been found, the countdown starts again. During a measurement, the EDS195PM shows recognized test current signals with pauses in between: i.e.  - - - .  
In the case of a measurement fault, the display permanently indicates pause (- - -). There are 3 reasons for this:
  - The insulation fault resistance is too high and cannot be measured by the EDS195PM.
  - The measuring clamp is not being held still. Hold the clamp still during measurement.
  - Low frequency residual currents or magnetic fields in the environment have been superimposed on the test current pulse. Avoid these disturbances.

12. Start the insulation fault location from the main distribution area of the IT system. Place the measuring clamp around all system conductors, **but not the PE conductor**. During each measurement wait one test cycle (approx. 30 seconds). A flashing alarm LED on the EDS195PM signals an insulation fault after (from the point of view of the locating current injector) the measuring clamp. It is recommended to have the buzzer activated during the search.
13. Now measure along the cable using the EDS195PM until the fault is found. During this process move into sub-distribution systems using a star-shaped approach. The location of the fault is found when the locating current in the measuring clamp generated by the PGH18... exceeds as a minimum the response value set on EDS195PM.

#### Possible error messages

- Self test error:
  - Incorrect current transformer type set
  - EDS195PM hardware faulty
  - Clamp moved while the indication ">>>Self test<<<" was displayed
  - An interfering residual current is flowing through the clamp
  - There is a PGH locating pulse acting on the clamp
- No CT connected:  
Measuring clamp or measuring current transformer not connected or faulty.
- Error  $I_{\Delta L}$  (can only be indicated while a measurement is in progress):
  - Low frequency interference, measurement not possible
  - EDS195PM hardware faulty
- $I_{\Delta n} > 10 \text{ A} / > 1 \text{ A}$ :  
There is a residual current  $> 10 \text{ A}$  or  $> 1 \text{ A}$  flowing through the measuring clamp. In this case it is not possible to locate the insulation fault on the related outgoing circuit. Residual currents of this magnitude in an IT system can be caused by large system leakage capacitances or multiple insulation faults. It is therefore possible that there is an insulation fault on this outgoing circuit also with this alarm message.



*At operating currents  $< 10 \text{ A}$  a measurement can also be made by placing the clamp around only one conductor. At currents  $> 10 \text{ A}$  it may no longer be possible to open the measuring clamp. This risk is particularly apparent in DC systems. If this effect occurs, under no circumstances apply force; this action would irreparably damage the measuring clamp. Instead the related system must be shut down. It will then be possible to open the measuring clamp without the need to apply force.*

### 6.12.2 Insulation fault location in a system with a permanently installed EDS system

The EDS195PM can also be used in a permanently installed EDS system (EDS460/490 or EDS461/491). In a large, complex IT system the main outgoing circuits are often monitored by the permanently installed EDS system. Once the main outgoing circuit affected by an insulation fault is detected, the search is continued from there using the portable EDS195PM.

During this process the EDS195PM uses the locating current pulse from the permanently installed EDS system (IRDH575, iso685-x-P or isoxx1685xP or PGH47...). The PGH18... is not required for this application.

The PGH18... is not included in the items supplied with the EDS3090 and EDS3091. Insulation fault location is therefore only possible in electrically live IT systems. Also follow the operating instructions for the permanently installed EDS system.





**DANGER**

#### **Risk of electric shock!**

*On touching live uninsulated conductors, death or serious injury may be caused. For this reason avoid any contact whatsoever with active conductors on positioning the measuring clamp.*

Example: The insulation monitoring device has signalled an insulation fault below its response value and started the permanently installed EDS system. The main outgoing circuit affected by the insulation fault has been detected. Proceed as follows for the further insulation fault location:

1. Set the mode of the EDS system to continuous insulation fault location:
  - IRDH575: On the "EDS Setup" menu set the "EDS on" mode
  - PGH471: Press "Start/Stop" button
2. Switch on the EDS195PM without a current transformer connected by pressing the  button. The device undertakes a self-test and outputs the error message "No CT connected" because a current transformer is not connected.
3. Now select the type of measuring clamp or measuring current transformer to be connected using the  button. The device undertakes a further self-test and outputs the error message "No CT connected" because a current transformer is not connected
4. Then connect the pre-selected measuring clamp or the pre-selected measuring current transformer to the EDS195PM. The device undertakes a further self-test and is then in the EDS mode. "IDL" appears in the first line of the display.
5. On handling measuring clamps note:
  - Do not bring measuring clamp into contact with system voltages above the nominal insulation voltage. (See nameplate on the measuring clamp with information on measuring category, e.g. CAT III)
  - Always keep contact surfaces on measuring clamp's iron core clean.
  - Do not use measuring clamp in the immediate vicinity of devices that produce magnetic fields such as transformers or chokes and also not near adjacent conductors carrying high currents.
  - Never disconnect measuring clamp from the EDS195PM while it is placed around electrically live conductors. Otherwise the measuring clamp may be irreparably damaged!
  - Aim for the best possible symmetry of the conductors in the measuring clamp. Otherwise the measuring clamp may go into saturation due to an excessively high load current and cause an alarm  $I_{\Delta n} > 10 \text{ A}$ .
  - **Keep the measuring clamp still** during the measurement!
  - During the measurement do not apply any pressure to the clamp limb.

6. Place the measuring clamp around the green-yellow wire between the IRDH575, iso685-x-P or isoxx1685xP or PGH47... and earth. If the EDS195PM does not react, the insulation fault has an excessively high impedance and cannot be detected. Locating current pulses detected are indicated using the symbol.
7. Start the insulation fault location in the outgoing circuit of the IT system already detected as faulty. Place the measuring clamp around all system conductors, **but not the PE conductor**. During each measurement wait one test cycle (approx. 30 seconds). A flashing alarm LED on the EDS195PM signals an insulation fault after (from the point of view of the locating current injector) the measuring clamp. It is recommended to have the buzzer activated during the search.
8. Now measure along the cable using the EDS195PM until the insulation fault is found. During this process move into sub-distribution systems using a star-shaped approach. The location of the fault is found when the locating current generated by the iso685-D-P, isoxx1685xP, IRDH575 or test current generator PGH47... in the measuring clamp exceeds as a minimum the response value set on EDS195PM.

#### Possible error messages

- Self test error:
  - Incorrect current transformer type set
  - EDS195PM hardware faulty
  - Clamp moved while the indication ">>>Self test<<<" was displayed
  - An interfering residual current is flowing through the clamp
  - There is a PGH locating pulse acting on the clamp
- No CT connected:  
Measuring clamp or measuring current transformer not connected or faulty.
- Error  $I_{\Delta L}$  (can only be indicated while a measurement is in progress):
  - Low frequency interference, measurement not possible
  - EDS195PM hardware faulty
- $I_{\Delta n} > 10 \text{ A} / > 1 \text{ A}$ :  
There is a residual current  $> 10 \text{ A}$  or  $> 1 \text{ A}$  flowing through the measuring clamp. In this case it is not possible to locate the insulation fault on the related outgoing circuit. Residual currents of this magnitude in an IT system can be caused by large system leakage capacitances or multiple insulation faults. It is therefore possible that there is an insulation fault on this outgoing circuit also with this alarm message.



*At operating currents  $< 10 \text{ A}$  a measurement can also be made by placing the clamp around only one conductor. At currents  $> 10 \text{ A}$  it may no longer be possible to open the measuring clamp. This risk is particularly apparent in DC systems. If this effect occurs, under no circumstances apply force; this action would irreparably damage the measuring clamp. Instead the related system must be shut down. It will then be possible to open the measuring clamp without the need to apply force.*



### 6.12.3 Insulation fault location in diode-decoupled DC systems

In diode-decoupled DC systems equalising currents occur in and between the decoupled circuits. The direction and magnitude of these equalising currents is dependent on voltages in the system, the characteristics of the decoupling diodes and the characteristics of the loads. On the usage of the insulation fault location system EDS309... in such systems these equalising currents make themselves apparent and can degrade the accuracy of the measurement. For this reason we recommend the usage of the EDS309... in diode-decoupled systems as shown in the sketch on the next page.



**DANGER**



#### **Risk of electric shock!**

*On touching live uninsulated conductors, death or serious injury may be caused. For this reason avoid any contact whatsoever with active conductors on connecting the PGH and positioning the measuring clamp.*

During this process please note:

- Always use two measuring clamps of the same type.  
Attention: this clamp type must also be set on the EDS195PM.
- For this purpose use the EDS195PM set (see ordering data, page 62).
- Take into account the maximum length of the coax cable of 10 m per measuring clamp.
- The usage of two measuring clamps results in a sensitivity loss of around 10 %.
- It is imperative both measuring clamps are used such that the direction of the flow of energy corresponds to the arrow printed on the clamp.

Example: The central insulation monitoring device in a DC system without permanently installed insulation fault location system (EDS) has signalled an insulation fault that is below the insulation value that can be located using the EDS system. Once all the instructions from "chapter 4. Considerations prior to use" have been followed, fault location in a modified form can be started. Proceed as follows during this process:

1. Read the actual insulation resistance on the insulation monitoring device. If the value read for the insulation resistance is lower than the maximum insulation fault that can be located by the EDS system, two appropriate identical measuring clamps (e.g. 2 x PSA3020 or 2 x PSA3052) are required for the insulation fault location.
2. Switch on the EDS195PM without a current transformer by pressing the  button. The device undertakes a self-test and outputs the error message "No CT connected".
3. Now select the type of measuring clamp(s) to be connected using the  button. The device undertakes a further self-test and outputs the error message "No CT connected" because a current transformer is not connected
4. Then connect the pre-selected measuring clamp(s) to the EDS195PM. The device undertakes a further self-test and is then in the EDS mode. "IDL" appears in the first line of the display
5. Connect the PGH18... to the locating current injection points are shown on page 51.
6. Start the EDS system:  
Switch on the PGH18.... The "ON" LED illuminates and the two and LEDs flash in synchronism with the test cycle. If there is no activity indicated on the LEDs, check the supply voltage and the fine-wire fuse fitted in the PGH18....
7. Insulation fault location in the system:
  - Place a measuring clamp around each of the supply cables to the redundantly supplied loads. During this process ensure that the clamp is placed around all related load supply cables for a diode-decoupled load.
  - Pay attention to identical directions of flow on the two measuring clamps (see connection diagram). For this purpose the measuring clamps are marked with an arrow

Place the two measuring clamps successively and systematically around all parallel outgoing cables for loads. Outgoing cables for loads with an insulation fault are indicated by the flashing alarm LED on the EDS195PM. The alarm messages are output in the same way as for an application with a single measuring clamp. For possible error messages see page 47.





Abb. 6.2: Insulation fault location in diode-decoupled DC systems (connection diagram)

#### 6.12.4 Usage of the EDS195PM as a residual current meter

The EDS195PM can be used as a residual current meter up to AC 10 A in TN and TT systems. Residual current measurement is only possible in electrically live systems. The locating current injector PGH18... is not required for this application.

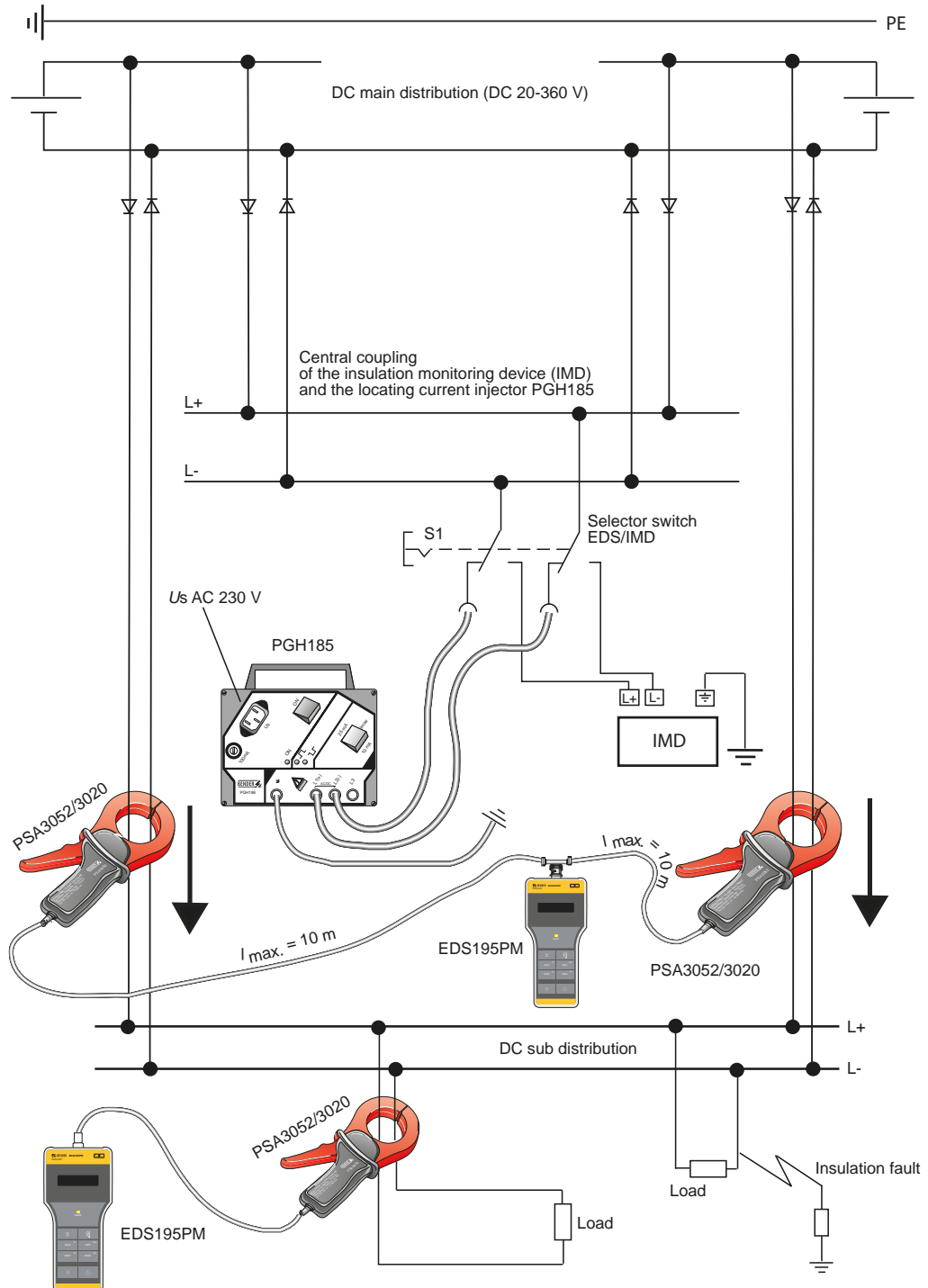

1. Check whether the system voltage is within the permissible limits.
2. Switch on the EDS195PM without a current transformer connected by pressing the  button. The device undertakes a self-test and outputs the error message "No CT connected" because a current transformer is not connected.
3. Now select the type of measuring clamp or measuring current transformer to be connected using the  button. The device undertakes a further self-test and outputs the error message "No CT connected" because a current transformer is not connected.
4. Then connect the pre-selected measuring clamp or the pre-selected measuring current transformer to the EDS195PM. The device undertakes a further self-test and is then in the EDS mode. "I $\Delta$ n" appears in the first line of the display.
5. Make the following settings:
  - Change to the I $\Delta$ n (RCM mode) function using the related button
  - Set residual current response value using the menu path "2. Settings /3. I $\Delta$ n ALM:"
6. On handling measuring clamps note:
  - Do not bring measuring clamp into contact with system voltages above the nominal insulation voltage. (See nameplate on the measuring clamp)
  - During the measurement place the clamp around all system conductors, **but not PE**. Do not place the clamp around screened conductors.
  - Always keep contact surfaces on measuring clamp's iron core clean.
  - Do not use measuring clamp in the immediate vicinity of devices that produce magnetic fields such as transformers or chokes and also not near adjacent conductors carrying high currents.
  - Never disconnect measuring clamp from the EDS195PM while it is placed around electrically live conductors. Otherwise the measuring clamp may be irreparably damaged!
  - Aim for the best possible symmetry of the conductors in the measuring clamp. Otherwise the measuring clamp may go into saturation due to an excessively high load current and cause an alarm I $\Delta$ n >10A.
  - **Keep the measuring clamp still or let go of it** during the measurement!
  - During the measurement do not apply any pressure to the clamp limb.
7. Start the measurement from the main distribution area of the system. Now measure along the cable using the EDS195PM until the insulation fault is found. During this process move into sub-distribution systems using a star-shaped approach.
8. EDS195PM indicates the residual current at each measuring point. If the residual current is greater than the response value set, the "ALARM" LED illuminates and the measured value is displayed. If the buzzer is activated, there is also an audible signal.
9. For long-term measurements at a point in the system, the fault memory is to be activated in the menu 2.4 (Settings/Memory). In this way it is also possible to find intermittent residual currents provided they are above the response value set. The highest residual current measured is saved.

### Possible error messages

- Self test error:
  - Incorrect current transformer type set
  - EDS195PM hardware faulty
  - Clamp moved while the indication ">>>Self test<<<" was displayed
  - An interfering residual current is flowing through the clamp
  - There is a PGH locating pulse acting on the clamp
- No CT connected:  
Measuring clamp or measuring current transformer not connected or faulty.
- Error  $I_{\Delta L}$  (can only be indicated while a measurement is in progress):
  - Low frequency interference, measurement not possible
  - EDS195PM hardware faulty
- $I_{\Delta n} > 10 \text{ A} / > 1 \text{ A}$ :  
There is a residual current  $> 10 \text{ A}$  or  $> 1 \text{ A}$  flowing through the measuring clamp. In this case it is not possible to locate the insulation fault on the related outgoing circuit. Residual currents of this magnitude in an IT system can be caused by large system leakage capacitances or multiple insulation faults. It is therefore possible that there is an insulation fault on this outgoing circuit also with this alarm message

### 6.12.5 Indication of the harmonics during residual current measurement

Using the EDS195PM it is also possible to measure harmonics of the fundamental frequencies of 50 or 60 Hz.

1. Switch on the EDS195PM by pressing the  button.  
The device is in the EDS mode.  $I_{\Delta L}$  appears in the first line of the display
2. Check correct setting for the selection of the clamp or current transformer on the display, correct if necessary
3. Now select the measurement type  $I_{\Delta n}$  (RCM mode) using the  button
4. Then make the following settings:
  - Check response value on menu 2.3 (Settings  $I_{\Delta n}$ ) and change if necessary
  - Check system frequency on menu 2.6 (Settings  $I_{\Delta n}$ ) and change if necessary
  - Activate measurement of the harmonics on menu 2.7 (Settings /Harmonics)
  - Select the required harmonics on menu 4.

The EDS195PM indicates the harmonics of a residual current at each measuring point. If the residual current is greater than the response value set, the "ALARM" LED flashes and the measured value is displayed. If the buzzer is activated, there is also an audible signal.

After the activation of the harmonics in menu 2.7, the harmonic with the greatest amplitude and the total harmonic distortion in % can be seen in the standard display with the menu closed.

### 6.13 Coupling device AGE185 for higher system voltages

This option is available for the variants EDS3090PG, EDS3090PG-13 and EDS3096PG with the locating current injectors PGH185 and PGH186. The coupling device AGE185 expands the nominal voltage range of the insulation fault location system EDS309...

The AGE185 reduces the losses in the locating current injector PGH18... As a result it makes it possible to connect the PGH18... to nominal system voltages up to AC 790 V or DC 960 V.



**Risk of electric shock!**

*On touching live uninsulated conductors, death or serious injury may be caused. For this reason avoid any contact whatsoever with active conductors on connecting the PGH or the AGE.*

**Assembly, connection and placing in operation**



*Only **qualified personnel** are permitted to carry out the work necessary to install, commission and run a device or system. Observe the rules for working on electrical installations.*

The ends of the wires from the AGE185 can be connected, as necessary and to suit the local situation, to the system's PE terminal and the PE socket on the PGH186; it is not necessary to take into account the polarity.

**Connection diagram**



Abb. 6.3: Connection diagram EDS309... with AGE185

## 6.14 Power supply for the EDS195PM

- The device is supplied with power using 3 NiMH cells of 1.2 V each or 3 mignon cells of type LR6 AA of 1.5 V each.
- **The power supply unit is not allowed to be connected with non-rechargeable batteries fitted!**
- On the connection of a power supply unit, there must be 3 correctly functioning **rechargeable batteries** in the battery compartment.
- Rechargeable battery charging time  $\leq 5$  h.

### 6.14.1 Displaying charge state

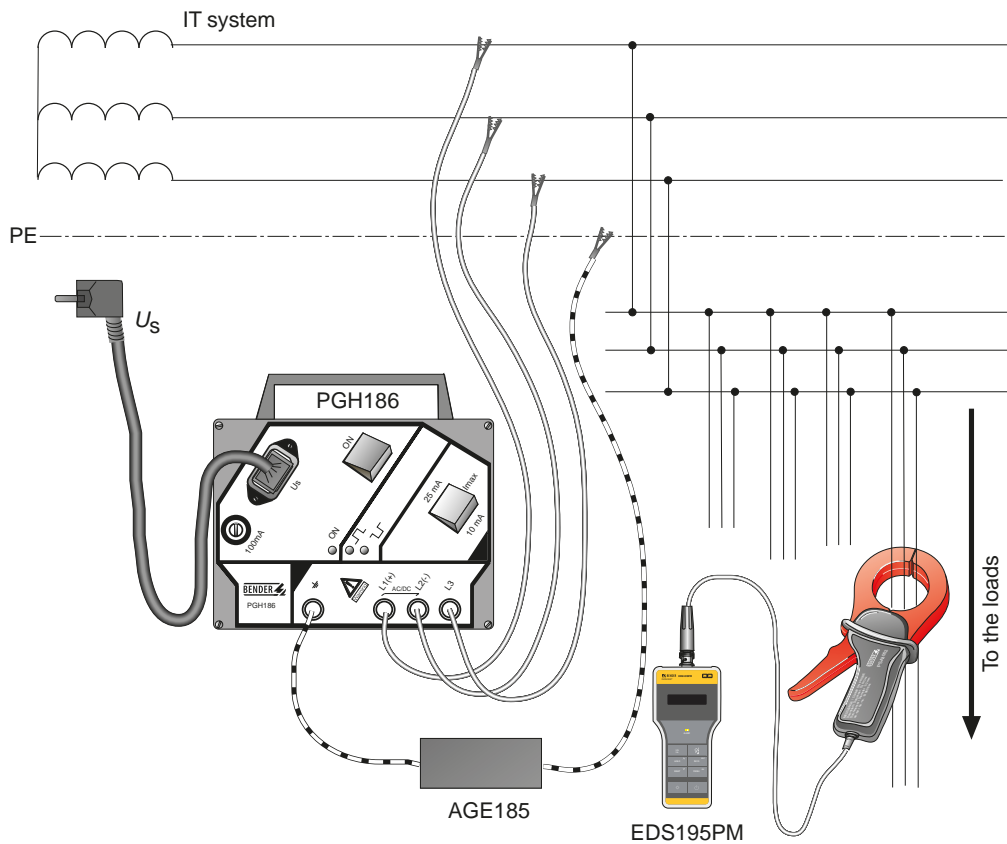
The display can indicate 4 different charge states: 100 %, 66 %, 33 % and a flashing empty battery symbol.

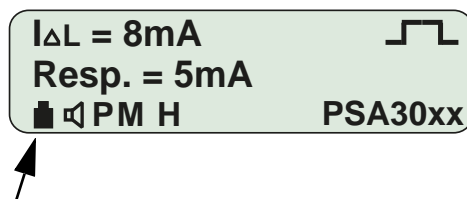

### 6.14.2 Changing batteries

The battery compartment is on the rear of the EDS195PM. The settings in the EDS195PM are retained on changing the batteries.

1. Undo 2 screws in the cover on the rear, remove cover.
2. Remove old batteries.
3. Fit new batteries in the battery compartment with correct polarity as indicated by the markings.
4. Close cover.

### 6.14.3 Power supply unit supplied



#### **Risk of incorrect triggering due to wrong measuring values!**

*Power supply unit influences the measuring accuracy of EDS195PM.  
Therefore, do not connect the power supply unit during measurements.*

A power supply unit with a USB connector and USB cable is included in the items supplied. The primary purpose of the power supply unit supplied is to charge the rechargeable batteries in the EDS195PM. See the display on the EDS195PM for the charge state of the rechargeable batteries.

## 7. Technical specifications

### 7.1 Technical specifications for the system EDS309...

The technical specifications stated in this section apply to the components PGH18..., EDS195PM, AGE185.

#### Environment/EMC

EMC .....	IEC 61326-2-4
Operating temperature .....	-10... + 55 °C
Climatic classes acc. to IEC 60721:	
Stationary use (IEC 60721-3-3) .....	3K23 (without condensation or icing)
Transport (IEC 60721-3-2) .....	2K11
Long-term storage (IEC 60721-3-1) .....	1K22
Classification of mechanical conditions acc. to IEC 60721:	
Stationary use (IEC 60721-3-3) .....	3M11
Transport (IEC 60721-3-2) .....	2M4
Long-term storage (IEC 60721-3-1) .....	1M12

#### Other

Operating mode .....	Continuous duty
Position in normal use .....	Any
Weight EDS309 ... ..	≤ 7000 g
Weight EDS309 ... with PSA3165 .....	≤ 8500 g
Weight EDS3092 .....	≤ 9000 g
Dimensions, case W x H x D .....	430 x 340 x 155 mm

### 7.2 Technical specifications PGH18...

#### Insulation coordination according to IEC 60664-1/IEC 60664-3

Rated voltage .....	500 V AC
Rated surge voltage / degree of pollution .....	4 kV/3

#### Nominal system voltage $U_n$

PGH183 .....	AC 42... 460 Hz 20... 265 V, DC 20... 308 V
PGH185 .....	3AC/AC 42... 460 Hz 20... 575 V, DC 20... 504 V
PGH186 .....	3AC/AC 42... 460 Hz 0... 575 V, DC 0... 504 V

#### Supply voltage

Supply voltage $U_S$ .....	AC 50... 60 Hz 230 V
Operating range of $U_S$ .....	0.85... 1.15 x $U_S$
Supply voltage $U_S$ version -13 .....	AC 50... 60 Hz 90... 132 V
Power consumption	
PGH 183, PGH 185 .....	≤ 3 VA
PGH 186: .....	≤ 6 VA

#### Locating current

Locating current, can be selected	
PGH183: .....	1/2.5 mA
PGH185/186: .....	10/25 mA
Test cycle .....	2 s
Pause duration .....	4 s

#### Locating voltage

PGH186 .....	DC 50 V
--------------	---------

#### Other

Degree of protection of built-in components DIN EN 60529 (VDE 0470-1)	IP40
Enclosure material	ABS plastic
Flammability class	UL94V-0
Weight	≤ 700 g
Dimensions	160 x 148 x 81 mm

### 7.3 Technical specifications EDS195PM

( )\* = Factory settings

#### Insulation coordination according to IEC 60664-1/IEC 60664-3

Rated voltage	50 V
Rated surge voltage/degree of pollution	0.8 kV/3

#### Supply voltage

Power supply $U_S$	Rechargeable batteries, batteries or USB power supply unit
Rechargeable batteries	3 x NiMH ≥ 2000 mAh
Operating time (without display lighting)	≥ 150 h
Charging time	≤ 5 h
Size	AA R6
Batteries	3 x LR6 AA – 1.5 V
USB power supply unit:	
Primary	100...240 V, 50...60 Hz
Secondary	DC 5 V, ± 10 %
Power consumption	≤ 0.5 W

#### Measuring circuit, insulation fault location

Nominal system voltage	With uninsulated conductors with measuring clamp up to 600 V
Rated frequency	DC, 42...2000 Hz
Main circuit ( $I_{Lmax} = 50$ mA):	
Measuring range	2...50 mA
Measuring clamps	PSA3020, PSA3052, PSA3165
Response sensitivity $I_{\Delta L}$ adjustable	2...10 mA (5 mA)*
Operating uncertainty	±30 % / ±2 mA of the nominal value
Control circuit: ( $I_{Lmax} = 5$ mA)	
Measuring range	0.2...5 mA
Measuring clamps	PSA3320, PSA3352
Response sensitivity $I_{\Delta L}$ adjustable	0.2...1.0 mA (0.5 mA)*
Operating uncertainty 0.2...0.9 mA	±30 % / ±0.2 mA of the nominal value
Operating uncertainty 1...5 mA	±30 % / ±2 mA of the nominal value

#### Measuring circuit, residual current

With measuring clamps	PSA3020, PSA3052, PSA3165
Measuring range	5 mA...10 A (crest factor up to 3)
Response sensitivity $I_{\Delta n}$ adjustable	10 mA...10 A (100 mA)*
Measuring clamps	PSA3320, PSA3352
Measuring range	2 mA...2 A (crest factor up to 3)
Response sensitivity $I_{\Delta n}$ adjustable	5 mA...1 A (100 mA)*
Frequency range	42...1000 Hz
Operating uncertainty, 42...60 Hz	±5 %
Operating uncertainty, 61...1000 Hz	±20 %
Hysteresis	20 %
Harmonics, indication can be disabled	1st to 8th harmonic



### Inputs

Connection for measuring clamp.....	BNC socket
Connection for power supply unit (DC 5 V) .....	µUSB socket

### Display

LCD .....	3 x 16 characters, illumination can be enabled
LED .....	Alarm

### Other

Degree of protection of built-in components DIN EN 60529 (VDE 0470-1) .....	IP40
Protective class according to IEC 60947-1, DIN EN 60947-1 (VDE 0660-100) .....	Class III
Enclosure material .....	ABS plastic
Flammability class .....	UL94V-0
Weight .....	≤ 350 g
Software version .....	D399 V2.0
Dimensions WxHxD .....	84 x 197 x 30 mm

## 7.4 Technical specifications measuring clamps

Note: The technical data for the CTA-F-set can be found at [www.bender.de/en/service-support/downloads](http://www.bender.de/en/service-support/downloads)

### Electrical safety

Standard .....	IEC 61010-2-030
Degree of pollution .....	2
System class .....	III
Operating voltage .....	600 V
Nominal insulation voltage .....	AC 600 V CAT III or AC 300 V CAT IV

### Transformer ratio

PSA30 .....	10 A/10 mA
PSA33 .....	1 A/0.1 mA
PSA3165 .....	10 A/10 mA

### Other

Degree of protection of built-in components DIN EN 60529 (VDE 0470-1) .....	IP40
Protective class according to IEC 60947-1, DIN EN 60947-1 (VDE 0660-100) .....	Class III
Measurement output .....	BNC connector
Dimensions PSA3052 / 3352 .....	216 x 111 x 45 mm
Dimensions PSA3020 / 3320 .....	135 x 65 x 30 mm
Dimensions PSA3165 .....	285 x 179 x 45 mm
Permissible cable diameter PSA3052 / 3352 .....	52 mm
Permissible cable diameter PSA3020 / 3320 .....	20 mm
Permissible cable diameter PSA3165 .....	115 mm
Weight PSA3052 / 3352 .....	≤ 700 g
Weight PSA3020 / 3320 .....	≤ 300 g
Weight PSA3165 .....	≤ 1300 g

## 7.5 Technical specifications AGE185

### Insulation co-ordination according to IEC 60664-1

Rated insulation voltage .....	AC 1000 V
Rated impulse voltage/degree of pollution .....	4 kV/3
Nominal system voltage $U_n$ .....	3 AC/AC 42...460 Hz, 500...790 V, DC 400...960 V

### Other

Degree of protection of built-in components DIN EN 60529 (VDE 0470-1) .....	IP30
Connection type/wire: .....	Safety laboratory connectors with green-yellow connection wire 1 mm <sup>2</sup>
Weight .....	≤ 200 g
Dimensions WxHxD: .....	88.5 x 42 x 21 mm

## 7.6 Standards and certifications

Observe the applicable national and international standards. The series EDS309... complies with the standards:

- DIN VDE 0100-410 (VDE 0100-410)  
Low-voltage electrical installations – Part 4-41:  
Protection for safety – Protection against electric shock (IEC 60364-4-41, modified);  
German version HD 60364-4-41
- DIN EN 61557-9  
Electrical safety in low voltage distribution systems up to 1000 V a.c. and 1500 V d.c. –  
Equipment for testing, measuring or monitoring of protective measures - Part 9:  
Equipment for insulation fault location in IT systems (IEC 61557-9);  
German version EN 61557-9
- DIN EN 61010-1; VDE 0411-1  
Safety requirements for electrical equipment for measurement, control and laboratory use –  
Part 1: General requirements (IEC 61010-1);  
German version EN 61010-1



## 7.7 Change log

Date	Document version	Software version	Changes / state
02.2022	07	-	Editorial revision p. 17 Table acc. to german Manual p. 17 p. 56 Climatic classes p. 58 CE + UKCA p. 59 Change log

## 7.8 Dimension diagrams

All dimensions are given in mm.

### Aluminium case

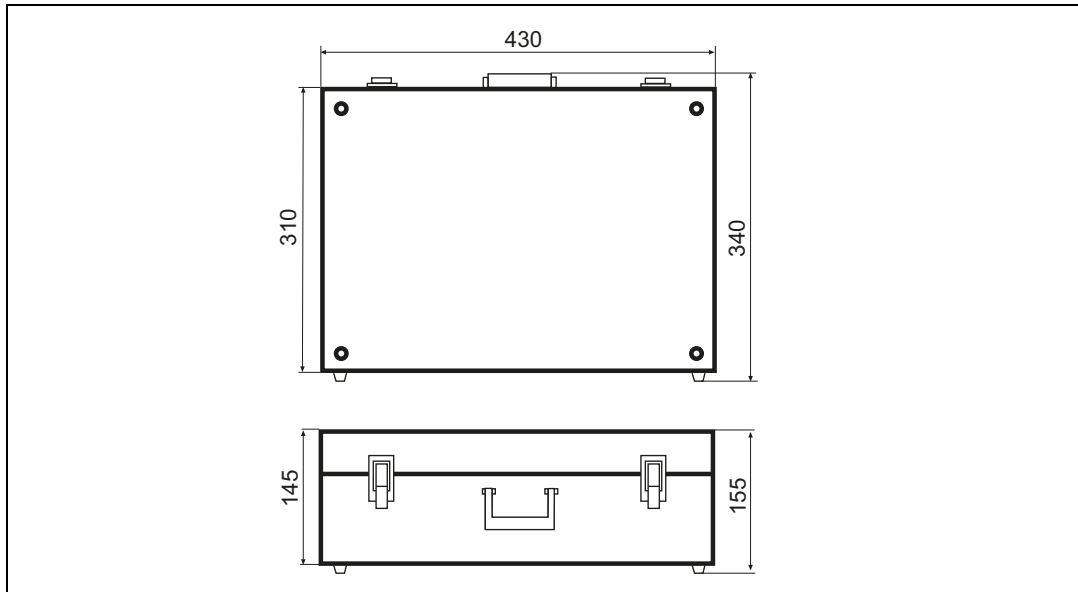

### AGE185

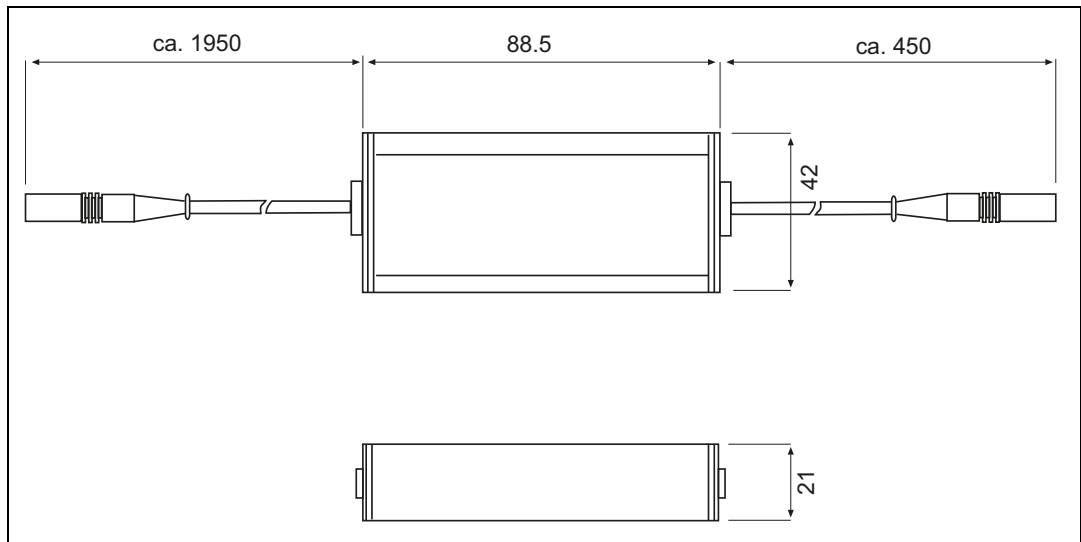

## 7.9 Status word

The status word can be checked by pressing the "INFO" button several times. This word contains the current configuration and provides an error code if there is a device error.

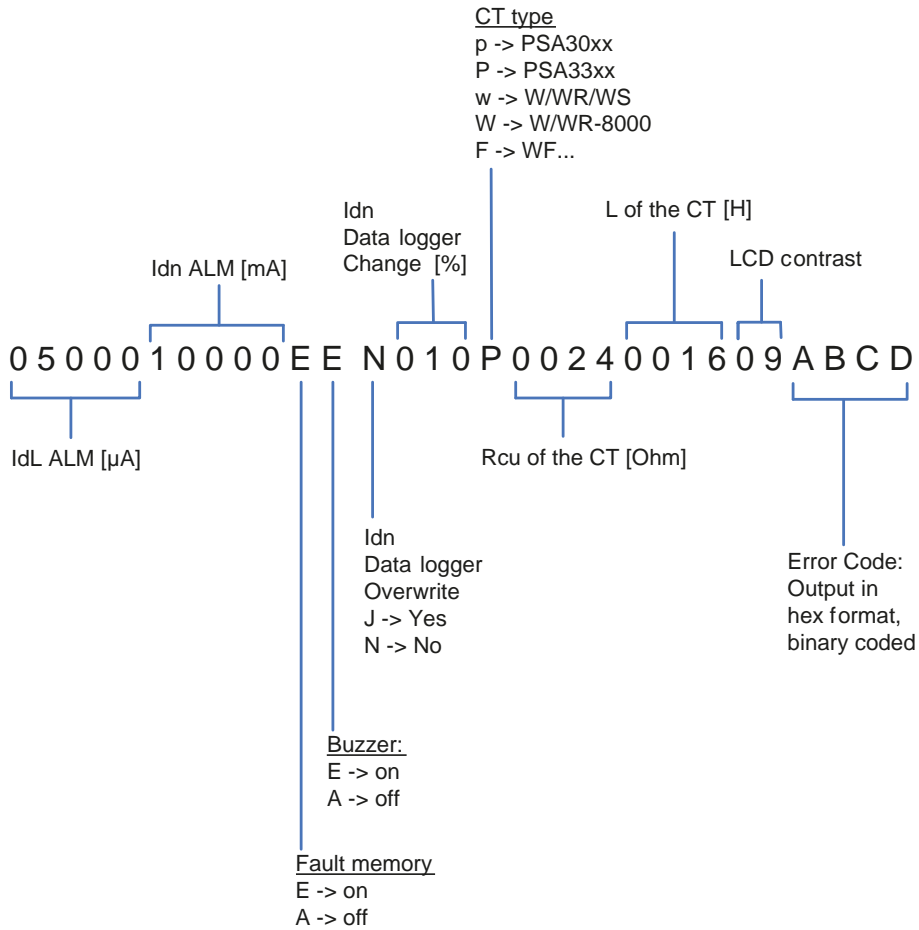

## 7.10 Ordering data including accessories

Ordering details						
Type	Items supplied			Supply voltage	Nominal voltage	Art.-No.
	Insulation fault locator	Locating current injector	Measuring current clamps 20 mm	Measuring clamps 52 mm		
EDS3090	EDS195PM		PSA3020	PSA3052	AC 42...460 Hz, 20...575 V und DC 20...504 V	B91082026
EDS3090PG	EDS195PM	PGH185	PSA3020	PSA3052	AC 50...60 Hz, 230 V	B91082021
EDS3090PG-13	EDS195PM	PGH185-13	PSA3020	PSA3052	AC 50...60 Hz, 90...132 V	B91082022
EDS3091	EDS195PM		PSA3320	PSA3352	AC 42...460 Hz, 20...265 V und DC 20...308 V	B91082027
EDS3091PG	EDS195PM	PGH183	PSA3320	PSA3352	AC 50...60 Hz, 230 V	B91082023
EDS3091PG-13	EDS195PM	PGH183-13	PSA3320	PSA3352	AC 50...60 Hz, 90...132 V	B91082024
EDS3092PG	EDS195PM	PGH183	PSA3320	PSA3352	AC 42...460 Hz, 20...265 V und DC 20...308 V	B91082030
		PGH185	PSA3020	PSA3052	AC 42...460 Hz, 20...575 V und DC 20...504 V	
EDS3096PG	EDS195PM	PGH186	PSA3020	PSA3052	AC 50...60 Hz, 230 V	B91082025
EDS3096PG-13	EDS195PM	PGH186-13	PSA3020	PSA3052	AC 50...60 Hz, 90...132 V	B91082029
EDS3096PV	EDS195PM	PGH186	–	2 x PSA3052	AC 50...60 Hz, 230 V	B91082031
<b>Optional Accessories</b>						
AGE185	Coupling device for increasing the voltage range of the PGH185/186				AC 42...460 Hz, 500...790 V, DC 400...960 V	B980305
Adapter cable BNC-PS2	Adapter cable for operating a WF current transformer on the EDS195P					B91082045
EDS-SET	BNC Tee connector and 2 BNC cables for fault location in diode-decoupled systems					B91082007
Plug power supply with USB connector	DC 5 V for external supply of the EDS195P via µUSB connector					A167054
PSA3165	Clamp 115 mm for EDS3090... and EDS3096...					B980852
CTAF SET	Clamp flexible for insulation fault location and differential method, with CTAF ENCLOSURE, CTAF500 BAND, CTAF1000 BAND, BNC cable, terminal, 2 x spare screws, case <b>Only in combination with EDS195PM</b>					B98080220
CTAF GEHÄUSE	CTAF enclosure as spare part for CTAF SET without BNC cable, with terminal and 2 x spare screws					B98110026
CTAF500 BAND	Band 500 mm as spare part for CTAF SET					B98110027
CTAF1000 BAND	Band 1.000 mm as spare part for CTAF SET					B98110028

## 7.11 Component list

Components EDS309...		
Device type	EDS195PM with Accessories	
	PGH18... with accessories for	Measuring clamps
EDS3090	Aluminium case with carrying handle	1
EDS3090PG	Operating manual	1
EDS3090PG-13	Insulation fault locator	EDS195PM
EDS3091	Clamping connector on 4 mm	1
EDS3091PG	Adapter BNC/4mm connector for curr. transform.	1
EDS3091PG-13	Adapter BNC-PS2 for WF-CT, <b>optional</b>	1
	Plug power supply for EDS195P	1
	Locating current injector	PGH185
	Supply cable for PGH18...	1
	Safety measuring cable, black	3
	Safety measuring cable, green/yellow	1
	Safety claw grip, black	3
	Safety claw grip, green/yellow	1
	Coupling device, <b>optional</b> (EDS3096PV only: in the scope of delivery)	AGE185
	Measuring clamps 20 mm	PSA3020
	Measuring clamps 52 mm	PSA3052
	Measuring clamps 115 mm, <b>optional</b>	PSA3165
	EDS-Set, <b>optional</b>	1
EDS3092PG		1
EDS3096PG		1
EDS3096PG-13		1

## 8. Additional fault location information using the EDS309x

There are times when locating a fault is not as straightforward as is described in the manual. The ISO-METER® indicates an insulation fault but the fault cannot be located using the EDS309x. With the aim of reducing multiple trips onsite and increasing customer satisfaction, this information sheet provides additional fault finding tips using the EDS309x. This information sheet should be used together with the latest version of the EDS309x manual.



### **Before travelling onsite:**

Ensure you take **ALL** equipment necessary to cover **ALL** possible troubleshooting needs.

### 8.1 Required equipment:

- EDS3090PG (B91082021)
- EDS3091PG (B91082023)
- PSA3165 (B980852)
- AGE185 (B980305)
- EDS-SET (B91082007)
- EDS195PM (B91082041)
- Portable oscilloscope

In the event you need to accurately measure the insulation resistance and generate a test current of 50 mA, the following equipment is needed:

- IRDH575B1- 435 (B91065500)
- IRDH575B2- 435 (B91065503)
- iso685-x-P
- isoxx1685xP

### 8.2 Collecting and analysing information

Before taking any measurements:

- **Obtain and scrutinize the plant drawings/layout:**
  - Make sure you familiarize yourself with all the outlets/measuring points and where they are.
- **Determine the system type:**
  - Main electricity grid (use the EDS3090PG)
  - Voltage controlled network (use the EDS3091PG)
- **Speak to as many people as possible:**
  - Ask when and how (under what circumstances) did the fault occur?
  - Find out what changes (if any) were made to the installation before the fault occurred by asking the following questions:
    - Were any new components added (system extension)?
    - Were any components replaced?

In one particular case, two DSL modems were installed. However, the plant employee working with Bender to locate the fault was totally unaware of this. It was subsequently discovered that the source

of the fault was a grounded negative power supply terminal.

### 8.3 Taking measurements

Use the PGH. . . to generate a defined test current. The magnitude of the current is dependent on the insulation fault present and the system voltage.



*Ensure there are no system components or loads (e.g. relays) in which the test current could cause a reaction that could be dangerous. Use a low test current to begin with and increase as required.*

The test current flows from the test current generator through the live conductors to the insulation fault by the shortest route. This locating current pulse is detected by the measuring clamps or measuring current transformers in the insulation fault path and is indicated by the insulation fault locator EDS195P.

If the location of the fault has not been determined after the initial standard measurements and all the standard questions have been asked (see FAQ in EDS309x manual) , the following points should be considered:

- Are there other outlets that have been missed? Check the plant layout again.
- Are we looking in the right location for the fault? The fault can also be inside the plant, on the distribution or sub-distribution lines, for example, or in the transformers, charging rectifiers or batteries of the power supply.
- Sometimes the return path of the current is not clear because of leakage capacitances, and the presence of other parallel faults or system interferences can result in reduced sensitivity. Interferences can also occur due to low-frequency residual currents or magnetic fields in the environment.

Because of these, the service engineer must **visually inspect and analyse the signal**. This is done using the EDS195PM fault locator and a portable oscilloscope. The EDS195PM has a measuring signal output that can be connected directly to the portable oscilloscope via a 50  $\Omega$  coaxial cable (RG58)



- see following diagrams.

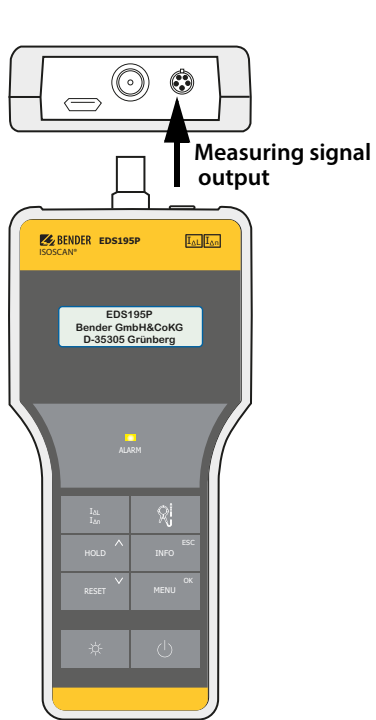

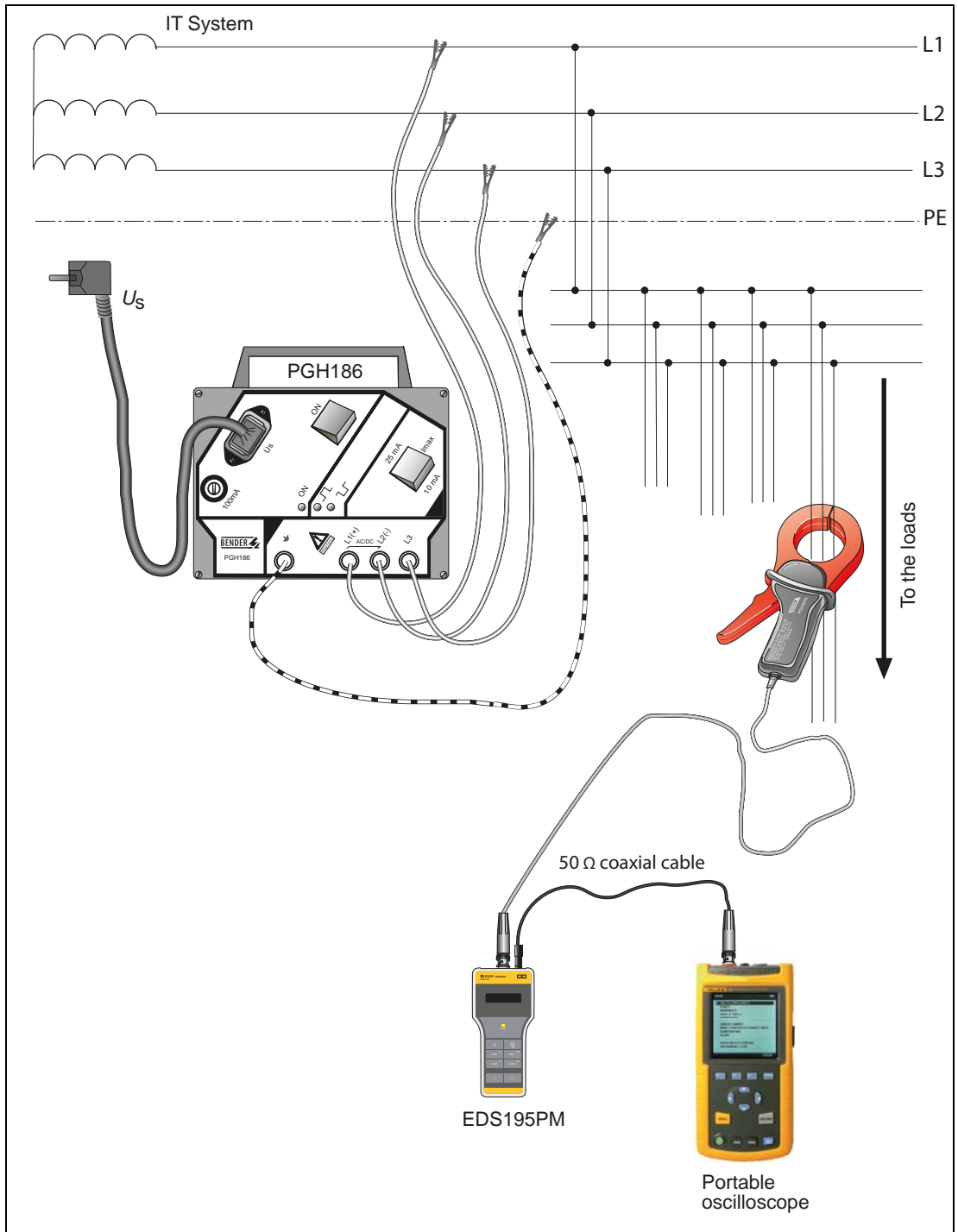

*EDS309... connectivity in an IT system*

In diode decoupled systems, parallel test signals can also be visually inspected by connecting as shown in a diode decoupled DC system below.

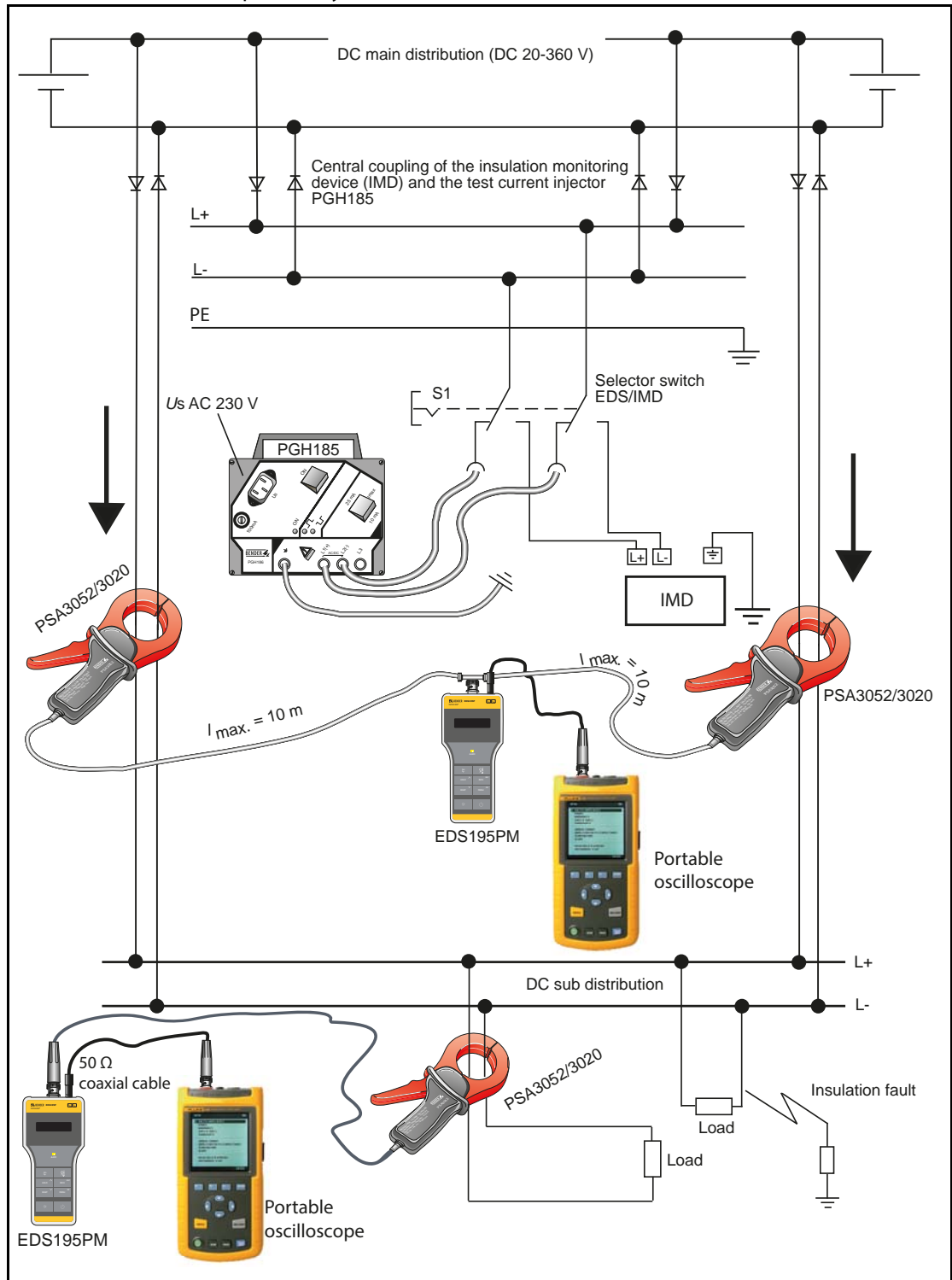

*Insulation fault location in a diode-decoupled DC system (connection diagram)*

A typical measured signal in systems without any interference is shown below (left). The amplitude of the signal is dependent on the magnitude of the test current. The alarm notification and the square wave pulse signalling a detected test current can be seen at the upper right-hand corner of the EDS195PM display (right).

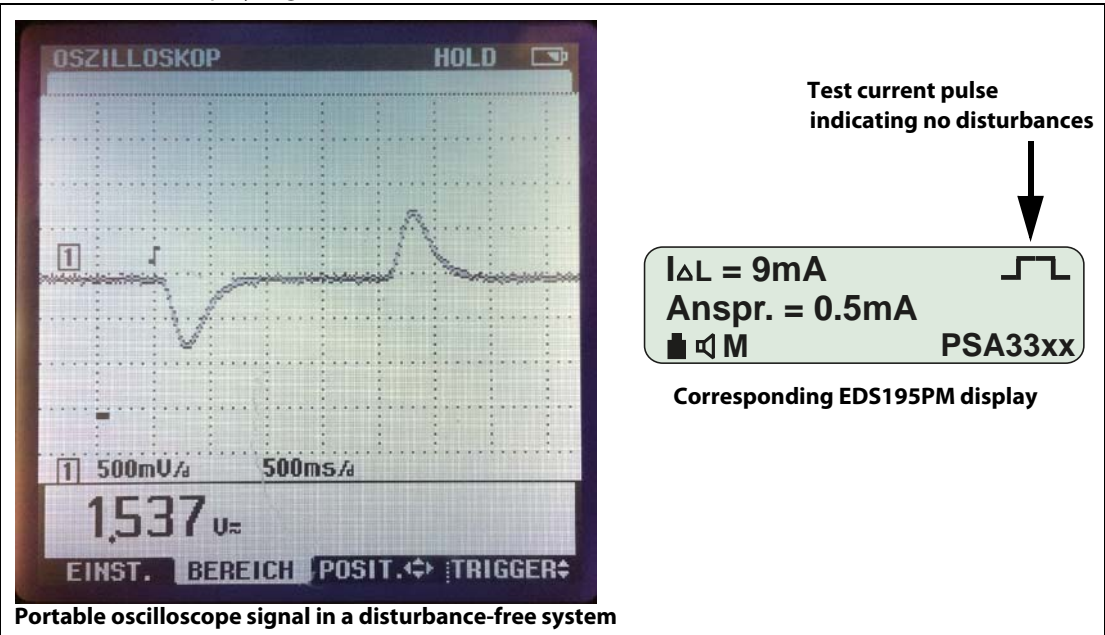

The measurement signal can, however, be affected by any number of problems (like those mentioned previously) so that the normal alarm notification is not given. In this case a visual detection of the signal by the portable oscilloscope is possible. The example below (left) shows a low-frequency disturbance. No alarm message appears on the EDS195PM display. Instead of the usual timer or the square wave pulse that signals a detected test current, only a "----" is visible in the upper right-hand corner.

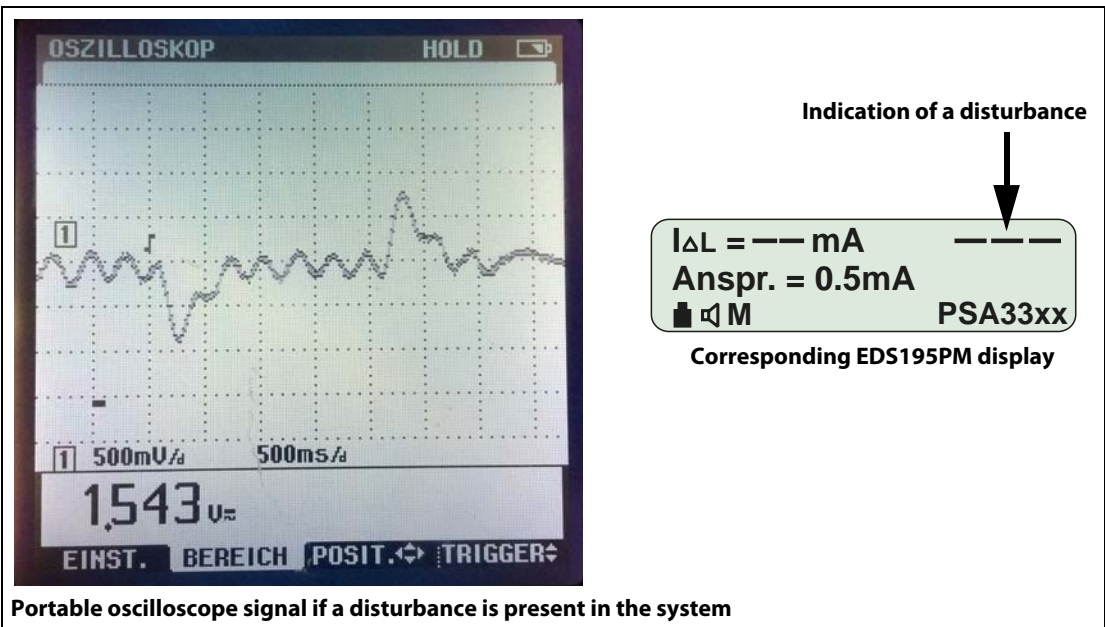

With this method, the test signal can be easily followed.

If the test signal displayed on the oscilloscope is very small, the following options are available:

- Increase the test current in the **main circuits** to 50 mA by means of the IRDH575, iso685-x-P or isoxx1685xP.
- Increase the test current in **control circuits** to 10 mA or 25 mA by means of the PGH185 under the following condition:
  - This should be done only in the case of an earth fault so that there is no influence on a controller. For this purpose, the following should be checked:
    - The isometer displays a value of  $< 1 \text{ k}\Omega$ .
    - The voltage measurement on a line of all active line conductors (L-, L+, or L1, L2, L3, N) to earth (PE) must be  $< 1 \text{ V}$ .
- The PSA33xx is typically used for control circuits into which a test current of up to 2.5 mA has been injected. However, in connection with the EDS195P(M), test currents of up to 10 mA can also be measured. With this method higher sensitivity is achieved and a clearer measurement signal displayed is on the oscilloscope.



#### **Fault finding in diode decoupled DC systems:**

*If the distance to the switchgear is such as to prevent the use of two parallel measuring clamps (as shown on page 7), proceed as follows:*

- Use only one measuring clamp
- Experience has shown that the signal in a system with a disturbance is similar to that shown on page 8, and often the disturbance can be visually detected with an oscilloscope
- If necessary, increase the test current as described above



#### **Fault finding in AC systems:**

*If the insulation fault cannot be localized using the  $I_{\Delta L}$  function, then measure the differential current by means of the  $I_{\Delta N}$  function (this is possible, at least in the case of an earth fault). The output with the highest differential current amplitude is usually where the fault lies. In exceptional cases, the output with the highest differential current amplitude is also the one with the highest leakage capacitance.*

*This must be considered when using this fault finding method. In this case, the differential current amplitude becomes smaller the further the measuring location is from the IT system supply.*

# INDEX

## A

- Accessories
  - optional 15
- AGE185 53
- Alarm is also output audibly 37, 41
- Alarm LED 34
- Alarms during EDS measurement or RCM measurement 39

## B

- Buttons on the EDS195PM 34

## C

- Cables
  - screened 17
- Characteristics, response sensitivity 25
- Charge state of the rechargeable battery 37
- Checking Info menu 36
- Checking the actual response values 34, 36
- Checking the device type 34
- Checking the software version 34
- Clamp change 36
- Clamp selection button 34, 37
- Component list 62
- Connecting the locating current injector 44
- Connection for external power supply unit 35
- Connection to an IT system 29, 30
- Coupling device AGE185 53

## D

- Deleting fault memory 35
- Device and measuring errors 39
- Device-specific safety instructions 11
- Diode-decoupled DC system 32, 49

- Disconnecting insulation monitoring device 28
- Display lighting 35
- Displaying harmonics 38
- Down button 35

## E

- EDS mode 16
- EDS195PM
  - controls 34

## F

- Factory settings 40
- Fault circuit 17
- Fault memory M is activated 37

## H

- HOLD button 35
- Hold function activated 37

## I

- Indication of the locating current pulse 37
- INFO button 60
- Insulation fault location
  - in a system without a permanently installed EDS system 44
  - in diode-decoupled DC systems 49
  - with permanently installed EDS system 47
- Insulation fault locator 16
- Intended use 11

## L

- Leakage currents 19
- Locating current 17
- Locating current limiting 24

## M

- Malfunction 39
- Measuring clamps
  - handling 45

- Measuring current transformers
  - commercially available 15
- Measuring harmonics 52
- Measuring residual current 16, 51
- Menu item
  - Harmonics 43
  - I $\Delta$ L alarms 43
  - I $\Delta$ n logger 44
  - Settings 42
  - System 43
- Menu structure 41

## N

- Navigating in the menu on the EDS195PM 42

## O

- Opening the menu 35
- Operating mode button 35
- Operating principle 17
- Operating the EDS195PM 35
- Ordering data 61
- Outline drawings 59

## P

- Permanently installed EDS system 32
- PGH18...
  - controls 33
- PLC 24
- Power supply for the EDS195PM 54
- Practical usage 44

## Q

- Quick check on the response values 36

## R

- RCM mode
  - function 20
- Rechargeable batteries 56
- Rechargeable battery
  - changing 54
- Reduced locating current 24

RESET button 35  
Residual currents  
- path 19  
Response characteristics for control circuits  
27  
Response characteristics for main circuits  
25

## S

Saving the measured value using HOLD 35  
Selecting the current transformer 34  
Selecting the operating mode 35  
Setting language 41  
Settings 42  
Significance of the display elements 37  
Standard display for EDS measurement 38  
Standard displays on the EDS195PM 38  
Standards 58  
Status word 60  
Switch on-off 35  
System components 13  
Systems  
- electrically isolated 28

## T

Technical specifications  
- AGE185 57  
- EDS195PM 56  
- measuring clamps 57  
- PGH18... 55  
Test cycle 18  
Type list EDS309... 14

## U

Up button 35  
USB power supply unit 56



## **Bender GmbH & Co. KG**

Londorfer Str. 65 • 35305 Grünberg • Germany  
PO Box 1161 • 35301 Grünberg • Germany

Tel.: +49 6401 807-0  
Fax: +49 6401 807-259

E-mail: [info@bender.de](mailto:info@bender.de)  
Web: <http://www.bender.de>



**BENDER Group**

---