



BENDER
CONNECT

ISOMETER® iso415R

Insulation monitoring device for unearthed
3(N)AC, AC and DC systems (IT systems)



Service and support for Bender products

First-level support

Technical support

Carl-Benz-Strasse 8 • 35305 Grünberg • Germany

Telephone: +49 6401 807-760

0700BenderHelp *

Fax: +49 6401 807-629

E-mail: support@bender-service.de

Available on 365 days from 7.00 a.m. to 8.00 p.m. (MEZ/UTC +1)

* Landline German Telekom: Mon-Fri from 9.00 a.m. to 6 p.m.: 6.3 cents/30 sec.; remaining time: 6.3 cents/min.

Mobile phone: higher, depending on mobile phone tariff

Repair service

Repair, calibration and replacement service

Londorfer Strasse 65 • 35305 Grünberg • Germany

Telephone: +49 6401 807-780 (technical issues) or

+49 6401 807-784, -785 (commercial issues)

Fax: +49 6401 807-789

E-mail: repair@bender-service.de

Field service

On-site service

Telephone: +49 6401 807-752, -762 (technical issues) or

+49 6401 807-753 (commercial issues)

Fax: +49 6401 807-759

E-mail: fieldservice@bender-service.de

Mon-Thu 7.00 a.m. to 4.00 p.m., Fri 7.00 a.m. to 1 p.m. (MEZ/UTC +1)

Inhaltsverzeichnis

1	General instructions	5
1.1	How to use this manual.....	5
1.2	Indication of important instructions and information	5
1.3	Training courses and seminars.....	5
1.4	Delivery conditions.....	5
1.5	Inspection, transport and storage	6
1.6	Warranty and liability.....	6
1.7	Disposal of Bender devices.....	6
1.8	Safety	7
1.9	Intended use	7
2	Function	8
2.1	Device features	8
2.2	Device-specific instructions.....	8
2.3	Functional description	8
2.3.1	Insulation fault R_f	9
2.3.2	Insulation fault location $R\%$	9
2.3.3	System leakage capacitance C_e	9
2.3.4	Connection monitoring L1/L2.....	9
2.3.5	Connection monitoring E/KE.....	10
2.3.6	Manual self test.....	10
2.3.7	Malfunction	10
2.3.8	Alarm assignments to the alarm relay.....	10
2.3.9	Delay times t_{br} , t , t_{on} and t_{off}	10
2.3.9.1	Recovery time t_b	10
2.3.9.2	Start-up delay t	10
2.3.9.3	Response delay t_{on}	10
2.3.9.4	Delay on release t_{off}	11
2.3.10	Factory settings FAC	11
2.3.10.1	Factory settings excluding interface parameters.....	11
2.3.10.2	Factory settings including interface parameters.....	11
2.3.11	Fault memory	11
2.3.12	Start with alarm	11

3	Mounting and connection.....	12
3.1	Mounting.....	12
3.2	Connection iso415R.....	13
3.2.1	Wiring diagrams	13
3.2.1.1	Supply voltage U_s	14
3.2.1.2	RS-485 interface	15
3.2.1.3	Relay	15
4	Operation and settings on the device	16
4.1	Control panel iso415R.....	16
4.1.1	STATUS LED.....	16
4.1.2	ALARM LEDs.....	17
4.1.3	VALUE DISPLAY LEDs.....	17
4.1.4	Detent potentiometer response value prewarning R_{an1}	17
4.1.5	Detent potentiometer response value main alarm R_{an2}	18
4.1.6	T/R button.....	18
4.1.6.1	"RESET" function	18
4.1.6.2	"TEST" function.....	18
4.1.6.3	"NFC" function	19
4.1.6.4	"ADDR" function.....	19
4.1.6.5	Write access to Modbus registers.....	20
5	Modbus settings.....	21
5.1	Overview.....	21
5.1.1	Read and write accesses	21
5.1.2	Data types.....	21
5.1.3	Register areas.....	21
5.2	Register table.....	22
6	Error – Cause – Error correction	27
7	Technical data.....	28
7.1	Standards & certifications	29
7.2	Ordering information	29
7.3	Document revision history	30

1 General instructions

1.1 How to use this manual



This manual is intended for qualified personnel working in electrical engineering and electronics! Part of the device documentation, in addition to this manual, are the enclosed "Safety instructions for Bender products".



Read the manual before mounting, connecting and commissioning the device. Always keep the manual within easy reach for future reference.

1.2 Indication of important instructions and information



DANGER! Indicates a high risk of danger that will result in death or serious injury if not avoided.



WARNING! Indicates a medium risk of danger that can lead to death or serious injury if not avoided.



CAUTION! Indicates a low-level risk that can result in minor or moderate injury or damage to property if not avoided.



Information can help to optimise the use of the product.

Signs and symbols



Disposal



Recycling



Temperature range



Protect from moisture



Protect from dust



RoHS directives

1.3 Training courses and seminars

www.bender.de/en -> Know-how -> Seminars.

1.4 Delivery conditions

The conditions of sale and delivery set out by Bender apply. These can be obtained from Bender in printed or electronic format.

The following applies to software products:



"Software clause in respect of the licensing of standard software as part of deliveries, modifications and changes to general delivery conditions for products and services in the electrical industry."

1.5 Inspection, transport and storage

Check the shipping and device packaging for transport damage and scope of delivery. The following must be observed when storing the devices:

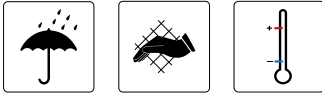

1.6 Warranty and liability

Warranty and liability claims in the event of injury to persons or damage to property are excluded in case of:

- Improper use of the device.
- Incorrect mounting, commissioning, operation and maintenance of the device.
- Failure to observe the instructions in this operating manual regarding transport, commissioning, operation and maintenance of the device.
- Unauthorised changes to the device made by parties other than the manufacturer.
- Non-observance of technical data.
- Repairs carried out incorrectly.
- Use of accessories and spare parts not recommended by Bender.
- Catastrophes caused by external influences and force majeure.
- Mounting and installation with device combinations not recommended by the manufacturer.

This operating manual and the enclosed safety instructions must be observed by all persons working with the device. Furthermore, the rules and regulations that apply for accident prevention at the place of use must be observed.

1.7 Disposal of Bender devices

Abide by the national regulations and laws governing the disposal of this device.



For more information on the disposal of Bender devices, refer to

www.bender.de/en -> [Service & support](#).

1.8 Safety

If the device is used outside the Federal Republic of Germany, the applicable local standards and regulations must be complied with. In Europe, the European standard EN 50110 applies.



DANGER! Risk of fatal injury due to electric shock! Touching live parts of the system carries the risk of:

- ***A FATAL ELECTRIC SHOCK***
- ***DAMAGE TO THE ELECTRICAL INSTALLATION***
- ***DESTRUCTION OF THE DEVICE***

BEFORE INSTALLING AND CONNECTING THE DEVICE, MAKE SURE THAT THE INSTALLATION HAS BEEN DE-ENERGISED. THE RULES FOR WORKING ON ELECTRICAL SYSTEMS MUST BE OBSERVED.

1.9 Intended use

The ISOMETER® is an insulation monitoring device according to IEC 61557-8 for IT systems. It monitors the insulation resistance of unearthed 3(N)AC, AC and DC main and control circuits (IT systems). The range of application and the maximum permissible system leakage capacitance of the different models are specified in the chapter "Technical data".

The DC components existing in AC/DC systems can have an influence on the response behaviour if an insulation fault occurs downstream of rectifiers with an electrolytic capacitor.

The separate supply voltage of the iso415R-24 also makes it possible to monitor a de-energised system.

Intended use implies:

- Observance of all information in this operating manual
- Compliance with test intervals

In order to meet the requirements of applicable standards, customised parameter settings must be made on the equipment in order to adapt it to local equipment and operating conditions. Please heed the limits of the area of application indicated in the technical data.

Any other use than that described in this manual is regarded as improper.

2 Function

2.1 Device features

- Monitoring of the insulation resistance for unearthed 3(N)AC, AC and DC systems with galvanically connected rectifiers
- Automatic adaptation to the system leakage capacitance up to 25 μF
- Response time $\leq 6 \text{ s}$ at $C_e = 1 \mu\text{F}$ and $R_f = R_{an}/2$
- Automatic device self test with connection monitoring
- Two separately adjustable response value ranges from 5 k Ω ...1000 k Ω
- Alarms are output via LEDs (AL1, AL2) and an alarm relay
- Selectable N/C or N/O relay operation ¹
- Selectable start-up delay, response delay and delay on release ¹
- Fault memory ¹
- RS-485 interface with Modbus RTU protocol
- NFC interface

2.2 Device-specific instructions



Operation inside a control cabinet.

Device signals must be visually perceptible outside the control cabinet.



IT systems with several ISOMETER®s.

Only one ISOMETER® may be installed in a galvanically connected system. In IT systems that are interconnected via coupling switches, ISOMETER®s that are not required must be disconnected from the IT system or deactivated. If IT systems are coupled via capacitances or diodes, central control of the various ISOMETER®s must be provided.



Prevent measurement errors!

In galvanically coupled DC circuits, an insulation fault can only be detected correctly if a minimum current of $> 10 \text{ mA}$ flows through the rectifiers.

2.3 Functional description

The iso415R is used to monitor the insulation fault R_f and to determine its location in unearthed systems. In addition to the limit value comparison, functions for connection monitoring, detection of device-internal errors and exceeding the maximum permissible leakage capacitance C_e are available.

The measured value R_f as well as all messages and alarms are displayed via the LEDs on the control panel and can be read out via the interfaces (Modbus RTU and NFC). Furthermore, the messages and alarms are also output via relay K1, depending on the alarm assignments that can be set via the interfaces.

¹ with app and Modbus RTU

2.3.1 Insulation fault R_F

The insulation fault R_F is measured in the range of 1 k Ω to 10 M Ω in unearthed 3(N)AC, AC, DC and DC superimposed AC systems and output in the range of 1 k Ω to 1 M Ω via the value display LEDs. R_F can be read from the interface register "Insulation resistance" in the range of 1 k Ω to 10 M Ω . With each update of the measured value R_F , the Modbus register "Measured value update counter" is incremented.

The two response values R_{an1} and R_{an2} are available for the limit value comparison. The two values are set either manually via the detent potentiometers or in the "Ext" position via the interface registers "Response value R_{an1} " and "Response value R_{an2} ".

If R_F falls below the limit values R_{an1} or R_{an2} without interruption for the duration of t_{on} , the respective alarm AL1 or AL2 is set. If R_F exceeds the respective limit values plus hysteresis without interruption for the duration of t_{off} , the respective alarms AL1 or AL2 are deleted if the fault memory is disabled.

The alarms AL1 and AL2 can be assigned to relay K1 via the interface registers "Alarm assignment Alarm 1" and "Alarm assignment Alarm 2".

2.3.2 Insulation fault location R%

If the ISOMETER® detects a DC offset to earth of at least 10 V in the monitored system, the insulation fault location R% is assigned to the positive or negative conductor with + or - 100 %. This can occur when monitoring a DC system or an AC system with an insulation fault in the DC link. In the case of symmetrical faults or below 5 V, R% is set to 0. The value of R% can be read via the interface register "Insulation fault location".

2.3.3 System leakage capacitance C_e

If the measured value acquisition does not work due to an excessive system leakage capacitance C_e or excessive disturbances in the system, the message "max. C_e /fault" appears and is indicated by the LEDs. The message can be assigned to relay K1 via the interface register "Alarm assignment max. C_e /fault".

2.3.4 Connection monitoring L1/L2

The connection monitoring L1/L2 continuously checks the low-resistance connection between the terminals L1 and L2 of the ISOMETER® via the system to be monitored. If the resistance is too high, the alarm L1/L2 is triggered and indicated by the LEDs.

The alarm can be assigned to relay K1 via the interface register "Alarm assignment L1/L2".

If the fault memory is not enabled, the alarm is automatically cleared after the connection fault has been eliminated. Connection monitoring can be disabled via the interface register "Connection monitoring L1/L2".

2.3.5 Connection monitoring E/KE

The connection monitoring E/KE continuously checks the low-resistance connection of the ISOMETER® between terminal E and earth with the input KE. If the resistance is too high, the alarm E/KE is triggered and indicated by the LEDs.

The alarm can be assigned to relay K1 via the interface register "Alarm assignment E/KE". If the fault memory is not enabled, the alarm is automatically cleared after the connection fault has been eliminated.

2.3.6 Manual self test

By pressing the T/R button for > 3 s and < 6 s or by executing the Modbus function "Test", the device simulates an insulation fault and the connection to the system is checked. All LEDs light up. This message can be assigned to relay K1 via the interface register "Alarm assignment Test". After automatic completion of the test, the signalling status before the test is restored even if the fault memory is enabled.

i *The test button should be pressed and the self test, including the relay function, should be checked annually.*

2.3.7 Malfunction

If an internal device error occurs, the status LED lights up RED. The error code can be queried via the device interfaces.

2.3.8 Alarm assignments to the alarm relay

Based on the table „3.2.1.3 Relay“ on page 15, the alarms can be assigned to the relay via the device interface.

2.3.9 Delay times t_b , t , t_{on} and t_{off}

The times t_b , t , t_{on} and t_{off} described below delay the output of alarms via LEDs, relay and Modbus RTU.

2.3.9.1 Recovery time t_b

The recovery time is the time the device needs to be ready for measurement after connecting the supply voltage U_s .

2.3.9.2 Start-up delay t

After connecting the supply voltage U_s , the measuring function is delayed by the set time t (0...1800 s) plus the recovery time t_b .

2.3.9.3 Response delay t_{on}

The insulation monitoring device requires the operating time t_{ae} from the moment the measured value falls below a response value until this violation is detected. The corresponding alarm is only set if the violation is detected without interruption for the duration of the response delay time t_{on} (0...1800 s). The total response time t_{an} is the sum of the operating time t_{ae} and the response delay time t_{on} .

2.3.9.4 Delay on release t_{off}

When the fault memory is disabled, alarms are maintained until the measured value no longer violates the respective response value including hysteresis without interruption for the duration of the delay on release t_{off} (0...1800 s).

2.3.10 Factory settings FAC

The factory settings can be restored via the Modbus RTU interface. The required registers are described in the Modbus table in chapter 5.2 on page 22. There are two options for restoring the factory settings:

2.3.10.1 Factory settings excluding interface parameters

After restoring the factory settings, all previously changed settings are reset to the state upon delivery. The settings for the Modbus interface are not reset.

2.3.10.2 Factory settings including interface parameters

After restoring the factory settings, all previously changed settings including the settings for the Modbus interface and the device address are reset to the state upon delivery.

2.3.11 Fault memory

The fault memory can be enabled or disabled via the interface register "Fault memory". Stored alarms are reset by pressing the T/R button for > 1 s and < 3 s when the fault memory is enabled. The fault memory is factory-set to disabled.

2.3.12 Start with alarm

This function, which can be enabled via the interface register "Start with alarm", makes the device start with the measured value $R_F = 1$ k Ω when it is restarted. The resulting alarm messages AL1 and AL2 are displayed until the measured value R_F is above the respective limit values. The limit value hysteresis and the fault memory for the respective alarm are not active during this start phase.

3 Mounting and connection

i Only qualified personnel are permitted to carry out the work necessary to install, commission and run a device or system.



Risk of fatal injury due to electric shock! Touching live parts of the system carries the risk of:

- **A FATAL ELECTRIC SHOCK**
- **DAMAGE TO THE ELECTRICAL INSTALLATION**
- **DESTRUCTION OF THE DEVICE**

BEFORE INSTALLING AND CONNECTING THE DEVICE, MAKE SURE THAT THE INSTALLATION HAS BEEN DE-ENERGISED. THE RULES FOR WORKING ON ELECTRICAL SYSTEMS MUST BE OBSERVED.

3.1 Mounting

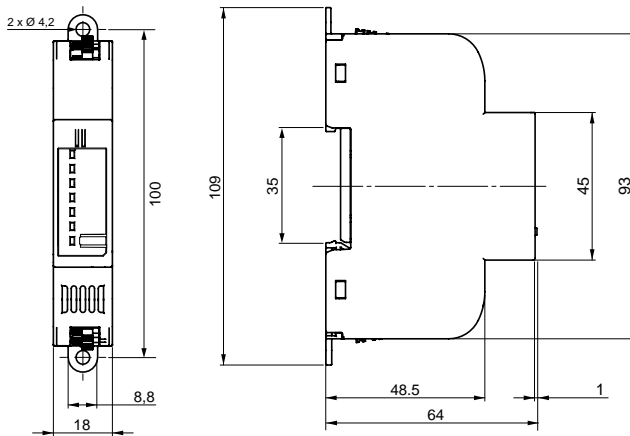
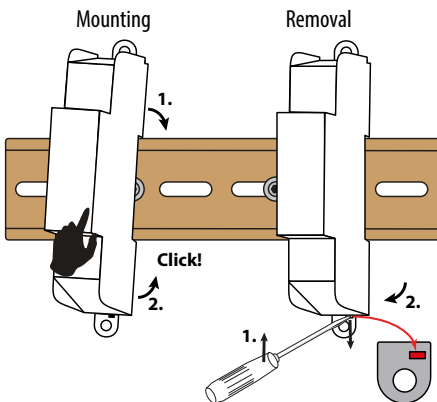
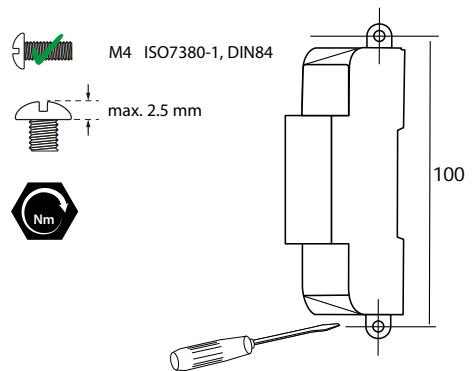

Fig. 3-1 Dimensions in mm

DIN rail mounting



Screw mounting



3.2 Connection iso415R

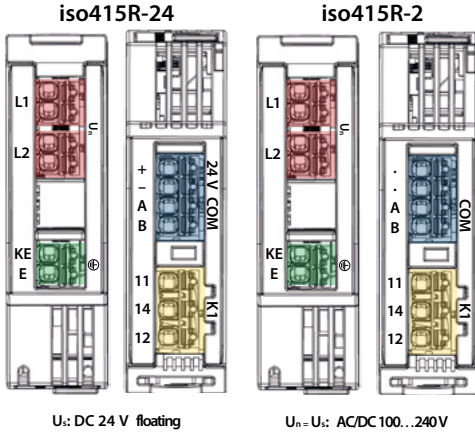

Terminal	Connection
L1, L2 iso415R-2	Nominal system voltage U_n $U_n = U_s$
E, KE	Earth, Control earth
11, 14, 12	Alarm relay K1
iso415R-24: + / -	U_s : DC, + 24V floating
iso415R-2: - / -	No function
COM A / B	RS-485 interface

CAUTION! SELECT CORRECT SUPPLY VOLTAGE!
 APPLYING AN EXCESSIVE SUPPLY VOLTAGE U_s CAN DESTROY THE DEVICE. CORRECT VALUES ARE:
 iso415R-24: $U_s = DC\ 24\ V$ (FLOATING!)
 iso415R-2: $U_s = U_n = AC/DC\ 100...240\ V$

3.2.1 Wiring diagrams

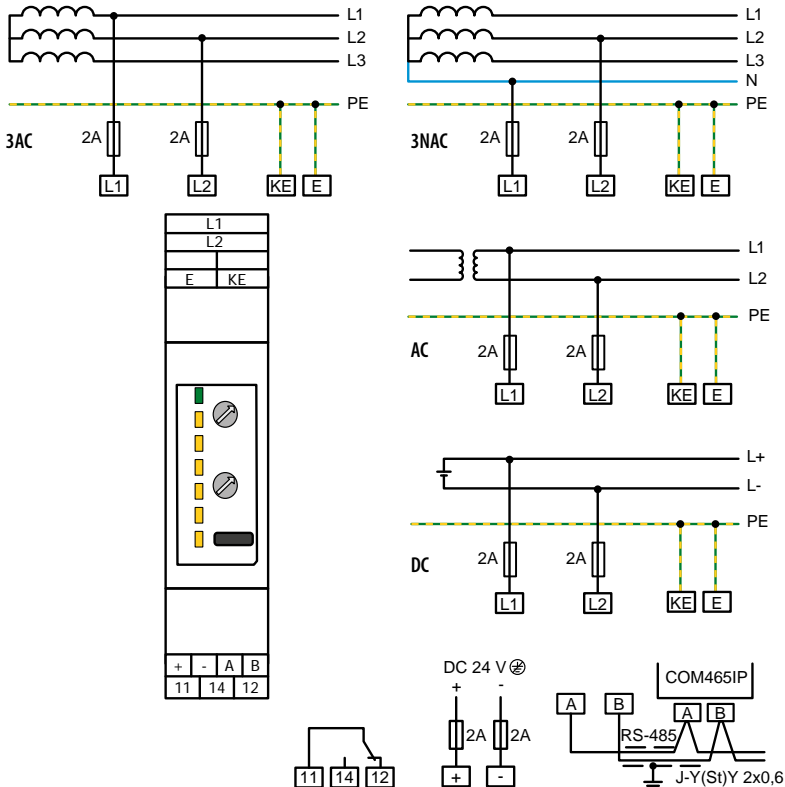

Fig. 3-2 Connections iso415R-24 and iso415R-2

The cables are connected to the device via push-in terminals. The maximum permissible conductor cross section is 1.5 mm².



CAUTION! Short circuit. When finely stranded cables are inserted directly into the push-in terminals, spliced wires can cause a short circuit. Use ferrules.

The terminals only allow the use of ferrules from 0.25 mm² to 1.5 mm². The maximum cross section of 1.5 mm² (including plastic sleeve) should under no circumstances be exceeded!

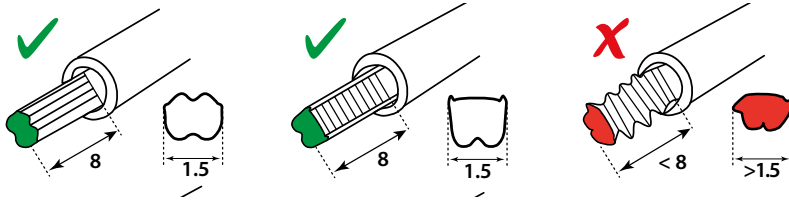

Use crimping pliers which

1. do not exceed the permitted crimp width of the ferrule and
2. do not leave strong crimp impressions on the ferrule.

i For a cross section of 0.75 mm² or more, use suitable crimping pliers similar to the models "CRIMPFOX 6", "Weidmüller PZ6" or "Weidmüller PZ6/5".

i For UL applications:
Use 60 °C/75 °C copper lines only!

3.2.1.1 Supply voltage U_s

iso415R-24

The iso415R-24 is supplied with DC 24 V via the + and - terminals. The DC 24 V source must not have a connection to earth.

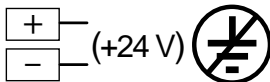

i No other devices that have a connection to earth may be supplied from this voltage source. (e.g. additional iso415R devices)

iso415R-2

The iso415R-2 is supplied from the system to be monitored via terminals L1 and L2. The permissible voltage is in the range of AC/DC 100...240 V.

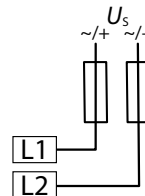

i The device must be provided with backup fuses (2 A) in both terminals.

3.2.1.2 RS-485 interface

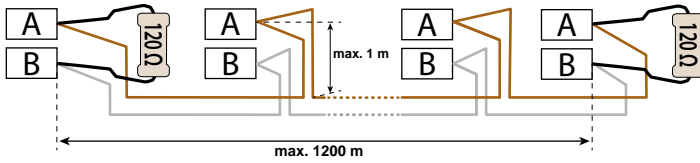

Specification

The RS-485 specification restricts the cable length to 1200 m and requires a daisy chain connection.

A twisted-pair, shielded cable must be used as bus cable. For example, cable type J-Y(St)Y n x 2 x 0.8 mm² is suitable. The shield must be connected to PE at one end.

Termination

The bus cable must be terminated at both ends with resistors (120 Ω, > 0.25 W). The terminating resistors are connected in parallel to the terminals A and B.

i If there are more than 16 bus devices, the interface must be designed to be shock-proof, because the maximum permissible total leakage current of 0.5 mA is exceeded.

3.2.1.3 Relay

The terminals 11,14,12 are relay outputs. The following settings can be made via the Modbus RTU interface:

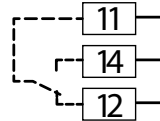

i Caution! High contact currents damage the hard gold plating of the relay contacts. Damaged contacts prevent the relay from switching correctly at low contact currents.

Function	State	Description
Relay mode	NO principle NC principle	The relay mode can be adapted to the application: <ul style="list-style-type: none"> • N/C NC operation of the contacts 11-14-12. In fault-free condition, the alarm relay is energised. • N/O NO operation of the contacts 11-14-12. In fault-free condition, the alarm relay is de-energised.
Test	on* off	This parameter determines whether the relay is actuated during a test
Main alarm	on* off	The relay switches when the measured value falls below the response value of the main alarm AL2
Prewarning	on off*	The relay switches when the measured value falls below the response value of the prewarning AL1
Device error	on* off	The relay switches if a device error exists
Connection fault system	on* off	The relay switches when there is a system connection fault (L1, L2).
Connection fault earth	on* off	The relay switches when there is a connection fault to earth (E, KE).
C _e exceeded	on* off	The relay switches when the permissible system leakage capacitance C _e is exceeded.

* Factory setting

4 Operation and settings on the device

4.1 Control panel iso415R

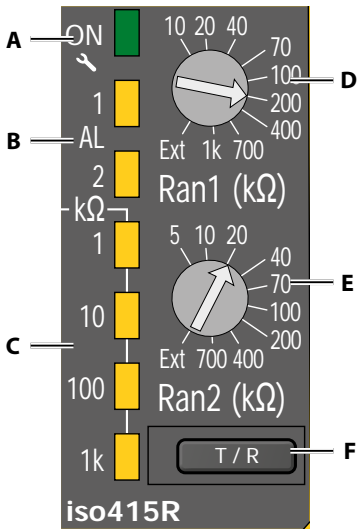

	Control panel
A	STATUS LED ON – operating modes
B	ALARM LEDs – AL1 / AL2
C	VALUE DISPLAY LEDs – 1, 10, 100, 1k kΩ (1k = 1000 kΩ = 1 MΩ)
D	DETENT POTENTIOMETER 1 – Response value prewarning R_{an1}
E	DETENT POTENTIOMETER 2 – Response value main alarm R_{an2}
F	T/R BUTTON – Test/Reset

i To confirm a new detent potentiometer position, the new position is output for a few seconds as a binary code (1= left stop, 10 = Ext) via the value display LEDs. The LED "1k" is the least significant bit (LSB).

4.1.1 STATUS LED

Multicoloured display of various operating modes.



LED	Operating mode
GREEN	START PHASE Device booting after start NORMAL OPERATION Device in fault-free state
YELLOW flashing with value display LED	CONNECTION FAULT <ul style="list-style-type: none"> System leakage capacitance C_e exceeded: LED "10" flashes Connection fault system(L1/L2): LED "100" flashes Connection fault earth (E/KE): LED "1k" flashes
RED	DEVICE ERROR Restart or replacement of the device required.
GREEN flashing blue	NFC ACTIVE

4.1.2 ALARM LEDs

Display of prewarning AL1 and main alarm AL2.

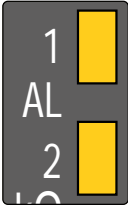

LED	Operating state
AL1	PREWARNING Lights permanently when the value falls below the prewarning threshold R_{an1} .
AL2	MAIN ALARM Lights permanently when the value falls below the main alarm threshold R_{an2} .

4.1.3 VALUE DISPLAY LEDs

Measured value display insulation resistance in kΩ

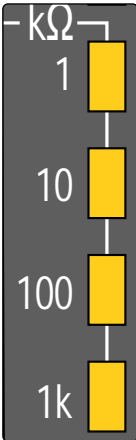

LED	Operating state
1	Lights permanently when the current measured value is ≤ 1 kΩ.
10	<ul style="list-style-type: none"> Lights permanently when the current measured value is ≤ 10 kΩ. Flashes synchronously with the yellow status LED when the system leakage capacitance C_e has been exceeded.
100	<ul style="list-style-type: none"> Lights permanently when the current measured value is ≤ 100 kΩ. Flashes synchronously with the yellow status LED when there is a connection fault of the system (L1/L2).
1k	<ul style="list-style-type: none"> Lights permanently when the current measured value is ≤ 1 MΩ. (1k = 1000 kΩ = 1 MΩ) Flashes synchronously with the yellow status LED when there is a connection fault to earth (E, KE).

4.1.4 Detent potentiometer response value prewarning R_{an1}

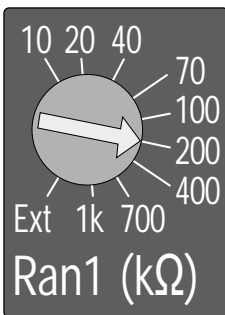

The response value R_{an1} can be set manually to the scaled values with the detent potentiometer and read from the Modbus register "Response value R_{an1} ".

Changing the response value in the Modbus register "Response value R_{an1} " is only possible in switch position "Ext".

The last response value R_{an1} stored via the interface can be read from the Modbus register "Response value R_{an1_ext} ". It is applied to the response value R_{an1} when the setting is changed from a manual value to "Ext".

4.1.5 Detent potentiometer response value main alarm R_{an2}

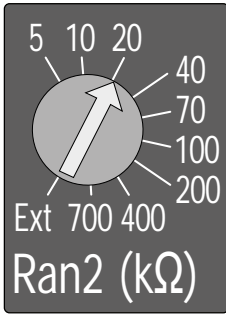

The response value R_{an2} can be set manually to the scaled values with the detent potentiometer and read from the Modbus register "Response value Ran2".

Changing the response value in the Modbus register "Response value Ran2" is only possible in switch position "Ext".

The last response value R_{an2} stored via the interface can be read from the Modbus register "Response value Ran2_ext". It is applied to the response value R_{an2} when the setting is changed from a manual value to "Ext".

4.1.6 T/R button

The T/R button activates different functions and editing modes depending on how long it is pressed.



Editing mode	Period	STATUS LED
RESET	1 s to 3 s	flashes yellow
TEST	3 s to 6 s	flashes red
NFC	6 s to 10 s	flashes blue
ADDR	10 s to 15 s	flashes green
PROTECT	20 s to 25 s	flashes violet

Overview

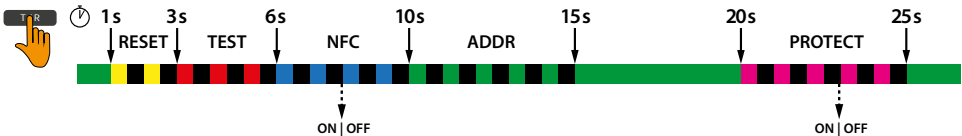

4.1.6.1 "RESET" function

The "RESET" function resets stored alarm states and disables the limit value hysteresis for that moment.

4.1.6.2 "TEST" function

The "TEST" function simulates an insulation fault for 5 seconds. During this period, the device has the following states:

- Display of the alarm value via the LEDs and the interface.
- The relays switches when the alarm assignment "Test" has been activated.
- The test status can be read out via the interface:
 - 0 = no test, 1 = internal test (local), 2 = external test (interface)
- t_{on} and t_{off} are set to 0 s for the duration of the test

4.1.6.3 "NFC" function

The "NFC" function changes the current activation state of the NFC interface when the T/R button is pressed for 6 to 10 seconds. The NFC interface is deactivated automatically after 5 minutes if it has not been manually deactivated beforehand.

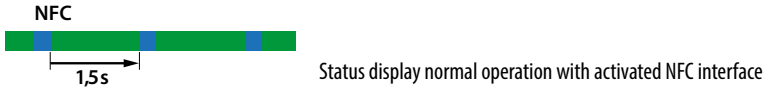

4.1.6.4 "ADDR" function

The "ADDR" function puts the device into the editing mode for the RS-485 address. The LED measured value display and the status LED indicate the devices address.

How to enter an address:

1. Press T/R button until the status LED flashes green.
 - After releasing the T/R button, the status LED lights RED.
2. Set HUNDREDS DIGIT. Briefly press the T/R button several times until the desired value is set. Press and hold T/R button once (> 2 s) to confirm.
 - After releasing the T/R button, the status LED lights GREEN.
3. Set TENS DIGIT. Briefly press the T/R button several times until the desired value is set. Press and hold the T/R button once (> 2 s) to confirm.
 - After releasing the T/R button, the status LED lights BLUE.
4. Set UNITS DIGIT. Briefly press the T/R button several times until the desired value is set. Press and hold the T/R button once (> 2 s) to confirm.
5. To exit the address setting mode, press and hold the T/R button once (2 s).
 - After releasing the T/R button, the status LED lights GREEN.

The address values are displayed via BCD code.

Addresses can only be entered within the valid address range. If no input is made for the period of 5 minutes, the addressing mode is automatically exited. The device then uses the currently set Modbus address.

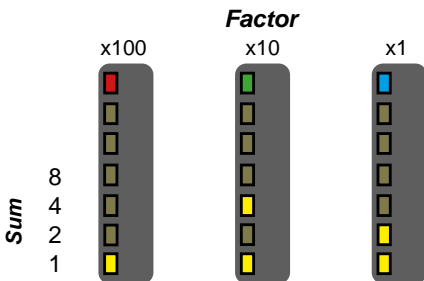

Current address: 153

4.1.6.5 Write access to Modbus registers

The " PROTECT" function disables or enables write access to the Modbus registers of the parameters. Via the Modbus register "Write access", write access can only be disabled, but no longer enabled.

- If the T/R button is pressed for at least 20 seconds, the status LED changes from steady green to flashing violet and remains in this state for 5 seconds if the button is held down.
- If the T/R button is released during the period in which the status LED flashes violet, the state of the Modbus register "Write access" changes from the current to the alternative setting, i.e. from "enabled" to "disabled" or vice versa.

5 Modbus settings

5.1 Overview

Description of the Modbus registers for iso415R devices. The following Modbus function codes are supported:

- Holding register for reading out values (Read Holding Register; function code 0x03)
- Register for device programming (Write Multiple Registers; function code 0x10)

For a complete Modbus protocol specification, visit <http://www.modbus.org>.

5.1.1 Read and write accesses

RO	READ ONLY (read access only)
RW	READ/WRITE (read and write access)
WO	WRITE ONLY (write access only)

5.1.2 Data types

Float	IEEE754 32-bit (single precision floating point number)
Int16	Signed 16-bit integer
Int32	Signed 32-bit integer
UInt16	Unsigned 16-bit integer
UInt32	Unsigned 32-bit integer
String UTF8	ASCII character string

5.1.3 Register areas

Range	Start address	End address
Info	0	99
Measurement status	999	3999
Alarm status	2000	2999
Range	3000	3999
Modbus RTU parameters	32000	32099
Relay parameters	32100	32199

Range	Start address	End address
Response value parameters	33000	33399
Monitoring parameters	33400	33499
Device error status	58000	58099
Interface parameters	59000	59099
Control commands	60000	60004

5.2 Register table

Address (dec)	Register name	Data type	Bytes	Mode	Value/Unit/Comment	Factory setting
Device information (0...99)						
0	Device name	String UTF8	32	RO	iso415R-24 or iso415R-2	N/A
16	Article number	String UTF8	32	RO	B71602000 (iso415R-24) B71603000 (iso415R-2)	N/A
32	Serial number	String UTF8	32	RO	10 digits e.g.: 2002123456	N/A
48	Manufacturer	String UTF8	32	RO	Bender	N/A
64	Application D number	Uuint16	2	RO	704 = D704	N/A
65	Application version number	Uuint16	2	RO	xxx = Vx.xx	N/A
66	Application build number	Uuint16	2	RO		N/A
67	Boot loader D number	Uuint16	2	RO	705 = D705	N/A
68	Bootloader version number	Uuint16	2	RO	xxx = Vx.xx	N/A
69	Boot loader build number	Uuint16	2	RO		N/A
70	Device status	Uuint16	2	RO	Bit 0 (LSB): NFC - 0 = disabled, 1 = enabled Bit 1: Potentiometer R_{m1} - 0 != ext, 1 = ext Bit 2: Potentiometer R_{m2} - 0 != ext, 1 = ext Bit 3-15: 0 (reserved)	N/A
Alarm and measured values (999...1999)						
999	Number of active alarms	Uuint16	2	RO	0...7	N/A
1000	Insulation resistance R_i	Uuint16	2	RO	0...10000 [kΩ]	N/A
1001	Alarm-1	Uuint16	2	RO	0 = No alarm 2 = Alarm, measured value below R_{an1}	N/A
1002	Alarm-2	Uuint16	2	RO	0 = No alarm 2 = Alarm, measured value below R_{an2}	N/A
1003	Measuring range status R_i	Uuint16	2	RO	0 = " " within measuring range 1 kΩ...10 MΩ 1 = "<" below measuring range 2 = ">" measuring range exceeded	N/A
Monitoring functions (2000...2999)						
2000	Alarm-E/KE	Uuint16	2	RO	0 = No alarm 2 = Alarm, E/KE connection faulty	N/A
2001	Alarm-L1/L2	Uuint16	2	RO	0 = No alarm 2 = Alarm, L1/L2 coupling faulty	N/A
2002	R_EKE	Uuint16	2	RO	0...1000 [kΩ]; Resistance between terminals E and KE	N/A
2003	R_L1L2	Uuint16	2	RO	0...1000 [kΩ]; Resistance between terminals L1 and L2	N/A
Status information (3000...3999)						
3000	Test status	Uuint16	2	RO	0 = No active test 1 = Internal test (local) 2 = External test (remote)	N/A
3001	Insulation fault location	Int16	2	RO	0 = Insulation fault cannot be located 100 = Insulation fault mainly at L1(+) -100 = Insulation fault mainly at L2(-)	N/A
3002	Measured value update counter	Uuint32	4	RO	0...2 ³²	N/A

Address (dec)	Register name	Data type	Bytes	Mode	Value/Unit/Comment	Factory setting
3008	Response value R _{an1_ext}	Uint16	2	RO	10...1000 [kΩ], the last response value stored via the interface	40 kΩ
3009	Response value R _{an2_ext}	Uint16	2	RO	5...700 [kΩ], the last response value stored via the interface	10 kΩ
Modbus RTU parameters (32000...32099)						
32000	Device address	Uint16	2	RW	1...247	Last 2 digits of the serial number + 100
32001	Baud rate	Uint32	4	RW	9600, 19200, 38400, 57600, 115200	19200
32003	Parity	Uint16	2	RW	1 = even 2 = odd 3 = none	1
32004	Stop bits	Uint16	2	RW	1 = 1 2 = 2 3 = automatic	3
32006	Update permission	Uint16	2	RW	0 = SW update via Modbus RTU not permitted 1 = SW update via Modbus RTU permitted	0
32007	Write access	Uint16	2	RW	1 = Write access enabled 2 = Write access disabled CAUTION! Writing of all parameters is disabled, enabling is only possible via the T/R button!!!	1
Relay (32100...32199)						
32100	Relay mode	Uint16	2	RW	1 = NO principle 2 = NC principle	2
32101	Alarm assignment test	Uint16	2	RW	0 = Disabled 1 = Enabled	1
32102	Alarm assignment device error	Uint16	2	RW	0 = Disabled 1 = Enabled	1
32103	Alarm assignment prewarning R _{an1}	Uint16	2	RW	0 = Disabled 1 = Enabled	0
32104	Alarm assignment main alarm R _{an2}	Uint16	2	RW	0 = Disabled 1 = Enabled	1
32105	Alarm assignment - connection fault E/KE	Uint16	2	RW	0 = Disabled 1 = Enabled	1
32106	Alarm assignment - connection fault L1/L2	Uint16	2	RW	0 = Disabled 1 = Enabled	1
32107	Alarm assignment Max. C _e /fault	Uint16	2	RW	0 = Disabled 1 = Enabled	1
Response values (33000...33099)						
33000	Response value prewarning R _{an1}	Uint16	2	RW	10...1000 [kΩ], step size 1 kΩ, writing is only possible when R _{an1} potentiometer is set to "Ext"	40 kΩ
33001	Response value main alarm R _{an2}	Uint16	2	RW	5...700 [kΩ], step size 1 kΩ, writing is only possible when R _{an2} potentiometer is set to "Ext"	10 kΩ

Address (dec)	Register name	Data type	Bytes	Mode	Value/Unit/Comment	Factory setting
Alarm behaviour (33200...33299)						
33200	Start with alarm	Uint16	2	RW	0 = Disabled 1 = Enabled	0
33201	Fault memory	Uint16	2	RW	0 = Disabled 1 = Enabled	0
Time behaviour (33300...33399)						
33300	Response delay	Uint16	2	RW	0...1800 [s], step size 1 s	0
33301	Delay on release	Uint16	2	RW	0...1800 [s], step size 1 s	0
33302	Start-up delay	Uint16	2	RW	0...1800 [s], step size 1 s	0
Monitoring functions (33400...33499)						
33400	Connection monitoring L1/L2	Uint16	2	RW	0 = Disabled 1 = Enabled	1
Device error codes (58000...58999)						
58000	Number of device errors	Uint16	2	RO	Number of active device errors	N/A
58001	E-KE connection fault	Uint16	2	RO	Error code = 30	N/A
58002	L1/L2 connection fault	Uint16	2	RO	Error code = 40	N/A
58003	Error firmware version too old	Uint16	2	RO	Error code = 321	N/A
58004	Error no firmware information	Uint16	2	RO	Error code = 325	N/A
58005	Error measurement technology timeout (C_u too high or disturbances in the system)	Uint16	2	RO	Error code = 405	N/A
58006	Calibration error	Uint16	2	RO	Error code = 600	N/A
58007	Write protection error	Uint16	2	RO	Error code = 631	N/A
58008	Read protection error	Uint16	2	RO	Error code = 651	N/A
58009	Error measurement technology HW	Uint16	2	RO	Error code = 820	N/A
58010	Error internal voltage 24V	Uint16	2	RO	Error code = 843	N/A
58011	Error internal voltage 3.5V	Uint16	2	RO	Error code = 846	N/A
58012	Error internal voltage V_{ref} 3.3 V	Uint16	2	RO	Error code = 849	N/A
58013	Error RAM microcontroller	Uint16	2	RO	Error code = 920	N/A
Control commands (59000...59999)						
59000	NFC	Uint16	2	RW	0 = Disabled 1 = Enabled (automatic disabling after 15 min)	Disabled
59001	Relay test	Uint16	2	RW	0 = Disable relay (automatic return to normal operating mode after 60 s) 1 = Enable relay (automatic return to normal operating mode after 60 s) 2 = Relay test inactive (normal operating mode)	Relay test inactive

Address (dec)	Register name	Data type	Bytes	Mode	Value/Unit/Comment	Factory setting
Control commands (60000)						
60000	Function selection	Uint16	2	WO	Function selection register to control the function of the following registers. Only specified values are permitted. 2 = Find device 4 = Reset to factory settings / Reset parameters 6 = Test 7 = Reset	N/A
Function 2: Find device						
60000	Function selection	Uint16	2	WO	2 → Selection of the "Find device" function	N/A
60001	Pattern value part 1	Uint16	2	WO	61918 → Safety pattern must be written for the function to be executed	N/A
60002	Pattern value part 2	Uint16	2	WO	0 → Safety pattern must be written for the function to be executed.	N/A
60003	Period	Uint16	2	WO	0...300 → Period in seconds during which the device lights up. If the device receives the value "0", the function is stopped.	N/A
Function 4: Reset to factory settings/Reset parameters						
60000	Function selection	Uint16	2	WO	4 → Selection of "Reset to factory settings/Reset parameters" function	N/A
60001	Pattern value part 1	Uint16	2	WO	64199 → Safety pattern must be written for the function to be executed	N/A
60002	Pattern value part 2	Uint16	2	WO	1304 → Safety pattern must be written for the function to be executed	N/A
60003	Type of reset	Uint16	2	WO	1 → Reset to factory settings including interface parameters 2 → Reset to factory settings excluding interface parameters	N/A
Function 6: Test						
60000	Function selection	Uint16	2	WO	6 → Selection of the "Test" function	N/A
60001	Pattern value part 1	Uint16	2	WO	32343 --> Safety pattern must be written for the function to be executed	N/A
60002	Pattern value part 2	Uint16	2	WO	0 → Safety pattern must be written for the function to be executed	N/A
60003	Type of test	Uint16	2	WO	1 → Start IMD test	N/A

Address (dec)	Register name	Data type	Bytes	Mode	Value/Unit/Comment	Factory setting
Function 7: Reset						
60000	Function selection	Uint16	2	WO	7 → Selection of "Reset" function	N/A
60001	Pattern value part 1	Uint16	2	WO	13623 → Safety pattern must be written for the function to be executed	N/A
60002	Pattern value part 2	Uint16	2	WO	0 → Safety pattern must be written for the function to be executed	N/A
60003	Type of reset	Uint16	2	WO	1 → Reset of the alarm message when fault memory is enabled	N/A

6 Error – Cause – Error correction

Error pattern	Cause	Correction	Source
RS-485			
Unstable system	Missing termination due to incorrect commissioning or defective component. No device is terminated.	Configure the terminating resistor, determine the terminating resistor value and replace it if necessary.	
	Faulty termination due to incorrect configuration or defective component. Only one or more than two devices are terminated.	Configure the terminating resistor, check quality of the bus signal.	
	Missing bias resistors in the master device	Installation and configuration of the missing bias resistors.	
No communication	Incorrect configuration: different baud rates between bus devices.	Calibrate baud rates between all bus devices.	
	Incorrect connection: terminals A and B are mixed up.	Establish correct bus wiring.	
Alarm relays			
Relays do not energise	No alarm message due to defective component or defective controlling devices. No alarm source has been assigned.	Check relay for proper function, replace device if necessary. Assign alarm sources.	
Relays do not de-energise	No alarm reset due to sticking or defective relay. Switching current > 5 A.	Replace device, if necessary. Observe technical data of the switching output.	
	No switching of the relay due to excessive preloads on contacts.	Observe technical data of the switching output.	
Enclosure			
Broken screw-mounting brackets	Device becomes detached due to broken mounting brackets.	Preventive measure: Use correct screw type and observe max. tightening torque. If the screw-mounting brackets are defective: mount on DIN rail or replace device.	
Non-compliance with the insulation guideline	Insufficient insulation due to insufficient distance between mounting screws and connecting wires.	Use screws with plastic cover or mount on DIN rail.	
Terminals			
Wires detach from the terminal	Due to splicing of wire ends, it is not possible to insert them into the terminal or hold them firmly in the terminal.	Use ferrules for mounting and connection to flexible cables.	
Wires cannot be removed from terminal	Ferrules with strong crimp impressions get stuck in the terminal	Use correct crimping pliers for mounting and connection with flexible cables.	

7 Technical data

Insulation coordination

acc. to IEC 60664-1/IEC 60664-3

Definitions:

Measuring circuit (IC1).....	L1, L2
Control circuit (IC2).....	E, KE, +, -, A, B
Output circuit (IC3).....	11, 14, 12
Rated voltage.....	400 V
Overvoltage category.....	III
Operating altitude.....	2000 m AMSL

Rated impulse voltage:

IC1/(IC2-3).....	6 kV
IC2/IC3.....	4 kV

Rated insulation voltage:

IC1/(IC2-3).....	400 V
IC2/IC3.....	250 V
Pollution degree.....	2

Protective separation between:

IC1/(IC2-3).....	Overvoltage category III, 600 V
IC2/(IC3).....	Overvoltage category III, 300 V

Voltage tests (routine test) acc. to IEC 61010-1

IC3/(IC1-2).....	AC 2.2 kV
------------------	-----------

Supply voltage

iso415R-24: Only via galvanically separated power supply (+/-)

Supply voltage U_s	DC 24 V
Tolerance of U_s	-20...+25 %
Power consumption.....	≤ 2 W
Inrush current (< 5 ms).....	< 10 A

iso415R-2: Only via the system to be monitored $U_s = U_n$ (L1/L2))

Monitored IT system iso415R-24

Tolerance of U_n	AC +15 %, DC +25 %
Frequency range of U_n	DC 42...460 Hz

Monitored IT system iso415R-2

Nominal system voltage $U_n = U_s$	100...240 V
3(N)AC, AC.....	100...240 V
DC.....	100...240 V
Tolerance of U_n	-30 %...+15 %
Frequency range of U_n	DC 42...460 Hz
Power consumption (at 50 Hz).....	≤ 2 W / ≤ 3.5 VA
Inrush current (< 2 ms).....	< 1.8 A

Measuring circuit

Measuring voltage U_m	±16 V
Measuring current I_m at $R_f, Z_f = 0 \Omega$	≤ 90 μ A
Internal resistance R_i, Z_i	≥ 180 k Ω
Permissible system leakage capacitance C_e	≤ 25 μ F
Permissible extraneous DC voltage U_{ig}	≤ 500 V

Response values

Response value R_{an1}	10...1000 k Ω (40 k Ω)*
Response value R_{an2}	5...700 k Ω (10 k Ω)*
Relative uncertainty R_{an}	±15 %, ±2 k Ω
Hysteresis R_{an}	25 %, minimum 1 k Ω

Time response

Response time t_{an} at $R_f = 0.5 \times R_{an}$ and $C_e = 1 \mu$ F	
acc. to IEC 61557-8.....	≤ 6 s
Start-up delay $t^{1)}$	0...1800 s (0 s)*
Response delay $t_{on}^{1)}$	0...1800 s (0 s)*
Delay on release $t_{off}^{1)}$	0...1800 s (0 s)*
Recovery time.....	< 0.4 s

Displays, memory

Display.....	status LED incl. LED bar graph (7 LEDs)
Display range insulation resistance (R_f).....	1...1000 k Ω
Measuring range insulation resistance (R_f).....	1...10000 k Ω ⁶⁾
Operating uncertainty.....	±15 % ±2 k Ω
Fault memory alarm messages ¹⁾	on/off (off)*

RS-485 interface

Protocol.....	Modbus RTU
Baud rate ¹⁾	max. 115.2 kbits/s (19.2 kbits/s)*
Parity ¹⁾	even, no, odd (even)*
Stop bits ¹⁾	1/2/ auto (auto)*
Cable length (9.6 kbits/s).....	≤ 1200 m
Cable: twisted pair ²⁾	min. J-Y(St)Y 2x0.6
Terminating resistor (external).....	120 Ω (0.25 W)
Device address, Modbus RTU ³⁾	1...247 (100 + SN)*

Switching elements

Switching elements.....	1 changeover contact
Operating principle ¹⁾ NC operation/NO operation (NC operation)*	
Electrical endurance, number of cycles.....	10000

Contact data acc. to IEC 60947-5-1:

Utilisation category.....	AC-12 / AC-14 / DC-12 / DC-12 / DC-12
Rated op. voltage.....	230 V / 230 V / 24 V / 110 V / 220 V
Rated op. current.....	5 A / 3 A / 1 A / 0.2 A / 0.1 A
Minimum contact rating ³⁾	1 mA at AC/DC ≥ 10 V

Connection

Connection type	Push-in
Nominal current	≤ 10 A
Connection properties	
rigid	0.2... 1.5 mm ² (AWG 24... 16)
flexible	0.2... 1.5 mm ² (AWG 24... 16)
with ferrule with plastic sleeve	0.25... 0.75 mm ²
with ferrule without plastic sleeve ⁴⁾	0.75... 1.5 mm ²

Environment/EMC

EMC	IEC 61326-2-4
-----------	---------------

Ambient temperatures

Operation	-25... +55 °C
Transport	-40... +85 °C
Storage	-40... +70 °C

Classification of climatic conditions acc. to IEC 60721 (ex- cept condensation and formation of ice)

Stationary use (IEC 60721-3-3)	3K23
Transport (IEC 60721-3-2)	2K11
Long-term storage (IEC 60721-3-1)	1K22

Classification of mechanical conditions acc. to IEC 60721

Stationary use (IEC 60721-3-3)	3M11
Transport (IEC 60721-3-2)	2M4
Long-term storage (IEC 60721-3-1)	1M12

Other

Operating mode	continuous operation
Mounting	cooling slots must be ventilated vertically
Degree of protection, internal components (DIN EN 60529)	IP30
Degree of protection, terminals (DIN EN 60529)	IP20
Enclosure material	polycarbonate
DIN rail mounting acc. to	IEC 60715
Flammability class	UL94 V-0
Documentation number	D00401
Weight	≤ 100 g

(¹⁾* Factory setting

¹⁾ Can be parameterised via app and Modbus

²⁾ When supplied by or when monitoring systems with a frequency ≥ 200 Hz, the cable must be laid in a shockproof manner.

³⁾ Refers to relays that have not been operated with high contact currents

⁴⁾ Use crimping pliers similar to CRIMPFOX 6 / Weidmüller PZ6/PZ6/5 only.

⁵⁾ Factory setting: 100 + last two digits of serial number

⁶⁾ Resolution/step size 1 kΩ

7.1 Standards & certifications

Devices of the iso415R series have been developed according to the following standards:

- IEC 61557-8



7.2 Licences

Open source software: https://www.bender.de/fileadmin/content/Products/t/0/Open-source_software_information.pdf

7.3 Ordering information

Supply voltage U_s		Nominal system voltage U_n		Type	Art. No.
AC/DC	DC	AC	DC		
	24V	0...415V	0...400V	iso415R-24	B71602000
100...240V		100...240V [(3)AC] 100...415V [3NAC]	100...240V	iso415R-2	B71603000

7.4 Document revision history

Date	Document version	Valid from software version	State/Changes
04/2021	00		
09/2021	01		Cover: Bender Connect APP p.15: Graphics and dim. of ferrules adapted to Phoenix specifications.
07/2022	02		p.28: TD "Monitored IT system iso415R-2": Line ' 3NAC [terminal L1 to N and terminal L2 to L(x)]......100...415V deleted p. 29: Chap. 7.2 "Licences" integrated Backcover: cUL-Logo



Alle Rechte vorbehalten.
Nachdruck und Vervielfältigung
nur mit Genehmigung des Herausgebers.

Bender GmbH & Co. KG

Postfach 1161 • 35301 Grünberg • Deutschland
Londorfer Str. 65 • 35305 Grünberg • Deutschland
Tel.: +49 6401 807-0 • Fax: +49 6401 807-259
E-Mail: info@bender.de • www.bender.de



All rights reserved.
Reprinting and duplicating
only with permission of the publisher.

Bender GmbH & Co. KG

PO Box 1161 • 35301 Grünberg • Germany
Londorfer Str. 65 • 35305 Grünberg • Germany
Tel.: +49 6401 807-0 • Fax: +49 6401 807-259
E-mail: info@bender.de • www.bender.de