



AC/DC

ISOMETER® iso685(W)-x-P

Insulation Monitoring Device with integrated locating current injector for IT AC systems with galvanically connected rectifiers and inverters and for IT DC systems

Software version: D440 V1.28



Table of contents

1	General information.....	7
1.1	How to use the manual.....	7
1.2	Indication of important instructions and information.....	7
1.3	Signs and symbols.....	7
1.4	Service and Support.....	7
1.5	Training courses and seminars.....	8
1.6	Delivery conditions.....	8
1.7	Inspection, transport and storage.....	8
1.8	Warranty and liability.....	8
1.9	Disposal of Bender devices.....	9
1.10	Safety.....	9
2	Function.....	10
2.1	Intended use.....	10
2.2	Device features.....	11
2.3	Product description.....	12
2.4	Function description.....	12
2.5	Insulation fault location.....	13
2.6	Interfaces.....	14
2.7	Self test.....	14
3	Device overview.....	15
3.1	Dimensions.....	15
3.2	Variants.....	15
3.3	Connection.....	16
3.4	Display elements and device buttons.....	17
3.5	Operating and navigating.....	18
4	Mounting.....	20
4.1	General instructions.....	20
4.2	DIN rail mounting.....	20
5	Connection.....	21
5.1	Connection requirements.....	21
5.2	Connection to a 3(N)AC system.....	22
5.3	Connection to a AC system.....	23
5.4	Connection to a DC system.....	23
5.5	Connection to a supply voltage.....	23

5.6	Connection to the X1 interface.....	25
5.7	Connection to the Ethernet interface ETH.....	25
5.8	Connection of the relay interfaces 1 and 2.....	26
5.9	Terminal covers.....	26
5.10	Connection to the BB bus.....	26
5.11	Connection of EDS44x/IOM441 to the ISOMETER®.....	27
6	Commissioning.....	32
6.1	General commissioning process.....	32
6.2	Initial commissioning.....	33
6.3	Commissioning an EDS.....	36
6.4	Recommissioning.....	37
6.5	Configuring password protection.....	37
7	Display.....	39
7.1	Standard display.....	39
7.2	Fault display (active).....	39
7.3	Fault display (inactive).....	40
7.4	Acknowledging a fault message.....	41
7.5	History memory.....	41
7.6	Data - isoGraph.....	41
7.7	Start initial measurement.....	42
7.8	ISOnet operation.....	42
7.9	ISLoop.....	43
7.10	Automatic test.....	43
7.11	Insulation fault location.....	43
8	Settings in the device menu.....	45
8.1	Menu structure.....	45
8.2	Settings.....	46
8.2.1	Alarm settings.....	46
8.2.2	EDS (insulation fault location).....	60
8.2.3	Data meas. values.....	77
8.2.4	Control.....	77
8.2.5	History.....	77
8.2.6	Device settings.....	77
8.2.7	Info.....	82
9	Device communication.....	83
9.1	Ethernet interface.....	83

9.2	BCOM.....	83
9.3	Modbus TCP.....	83
9.4	Web server.....	83
9.4.1	Conventions.....	84
9.4.2	Functions.....	84
9.4.3	User interface.....	85
9.4.4	Menu structure.....	86
9.4.5	Parameter changes.....	86
9.4.6	Changing parameters in a web browser.....	88
9.4.7	Changing parameters in the device menu when the web browser is open.....	89
9.4.8	Write access for parameter changes.....	89
9.5	BS bus.....	89
9.5.1	Master-slave principle.....	90
9.5.2	Addresses and address ranges on the BS bus.....	90
9.5.3	RS-485 specifications and cables.....	90
9.5.4	Cable routing.....	90
9.6	Modbus RTU.....	91
9.7	isoData protocol.....	91
10	Insulation fault location.....	95
10.1	General description.....	95
10.2	Required settings for insulation fault location.....	95
10.3	Indication on the display.....	95
10.4	Starting and stopping the insulation fault location.....	95
11	Special functions for coupled IT systems.....	96
11.1	Particularities when monitoring coupled IT systems.....	96
11.2	System isolation via digital input with two coupled systems.....	96
11.3	System isolation via ISONet.....	97
11.3.1	System connection diagrams.....	97
11.3.2	Configuration and function.....	98
11.3.3	ISONet priority.....	99
11.4	ISOloop.....	99
11.4.1	Preparing the devices in an interconnection.....	100
11.4.2	Creating groups with the <i>BCOM Group Manager</i>	101
11.4.3	Configuration and function on the ISOMETER®.....	104
11.5	EDSsync.....	105
11.5.1	Preparing the devices in an interconnection.....	106
11.5.2	Creating groups with the <i>BCOM Group Manager</i>	106

11.5.3	Activating the function on the ISOMETER®	109
12	Alarm messages.....	110
12.1	General alarms.....	110
12.2	Measured value alarms.....	111
12.3	ISOnet.....	111
12.4	ISOloop.....	111
12.5	EDS44x.....	112
12.6	EDSsync.....	112
13	Technical data.....	113
13.1	Factory settings.....	113
13.2	Device profiles.....	115
13.3	Tabular data iso685-x-P.....	121
13.4	Ordering details.....	128
13.5	Document revision history.....	130
14	Glossary.....	131

1 General information

1.1 How to use the manual



ADVICE

This manual is intended for qualified personnel working in electrical engineering and electronics! Part of the device documentation in addition to this manual is the enclosed supplement "Safety instructions for Bender products".



ADVICE

Read the operating manual before mounting, connecting and commissioning the device. Keep the manual within easy reach for future reference.

1.2 Indication of important instructions and information



DANGER

Indicates a high risk of danger that will result in death or serious injury if not avoided.



WARNING

Indicates a medium risk of danger that can lead to death or serious injury if not avoided.



CAUTION

Indicates a low-level risk that can result in minor or moderate injury or damage to property if not avoided.



ADVICE

Indicates important facts that do not result in immediate injuries. They can lead to malfunctions if the device is handled incorrectly.



Information can help to optimise the use of the product.

1.3 Signs and symbols



Disposal



Protect from moisture



Protect from dust

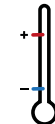

Temperature range



Recycling



RoHS directives

1.4 Service and Support

Information and contact details about customer service, repair service or field service for Bender devices are available on the following website: [Fast assistance | Bender GmbH & Co. KG](#).

1.5 Training courses and seminars

Regular face-to-face or online seminars for customers and other interested parties:

www.bender.de > know-how > seminars.

1.6 Delivery conditions

The conditions of sale and delivery set out by Bender GmbH & Co. KG apply. These can be obtained in printed or electronic format.

The following applies to software products:



"Software clause in respect of the licensing of standard software as part of deliveries, modifications and changes to general delivery conditions for products and services in the electrical industry"

1.7 Inspection, transport and storage

Check the shipping and device packaging for transport damage and scope of delivery. In the event of complaints, the company must be notified immediately, see "www.bender.de > service & support".

The following must be observed when storing the devices:

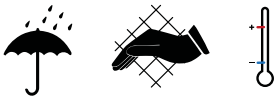

1.8 Warranty and liability

Warranty and liability claims for personal injury and property damage are excluded in the case of:

- Improper use of the device.
- Incorrect mounting, commissioning, operation and maintenance of the device.
- Failure to observe the instructions in this operating manual regarding transport, commissioning, operation and maintenance of the device.
- Unauthorised changes to the device made by parties other than the manufacturer.
- Non-observance of technical data.
- Repairs carried out incorrectly.
- The use of accessories or spare parts that are not provided, approved or recommended by the manufacturer.
- Catastrophes caused by external influences and force majeure.
- Mounting and installation with device combinations not approved or recommended by the manufacturer.

This operating manual and the enclosed safety instructions must be observed by all persons working with the device. Furthermore, the rules and regulations that apply for accident prevention at the place of use must be observed.

1.9 Disposal of Bender devices

Abide by the national regulations and laws governing the disposal of this device.



For more information on the disposal of Bender devices, refer to www.bender.de > service & support.

1.10 Safety

If the device is used outside the Federal Republic of Germany, the applicable local standards and regulations must be complied with. In Europe, the European standard EN 50110 applies.



DANGER *Risk of fatal injury due to electric shock!*

Touching live parts of the system carries the risk of:

- Risk of electrocution due to electric shock
- Damage to the electrical installation
- Destruction of the device

Before installing the device and before working on its connections, make sure that the installation has been de-energised. The rules for working on electrical systems must be observed.

2 Function

2.1 Intended use

The ISOMETER® monitors the insulation resistance of unearthed AC/DC main circuits (IT systems). The application range of the different types is specified in the chapter "Technical data", page 113. For the iso685-x and iso685-x-B types, the operating range of the nominal voltage U_n can be extended via coupling devices.

DC components existing in AC/DC systems do not influence the operating characteristics. A separate supply voltage allows de-energised systems to be monitored too. The maximum permissible system leakage capacitance is provided in the technical data.

Intended use also includes

- the observation of all information in the operating manual and
- compliance with test intervals.

In order to meet the requirements of the applicable standards, customised parameter settings must be made on the equipment in order to adapt it to local equipment and operating conditions. Please heed the limits of the range of application indicated in the technical data.

Do not make any unauthorised changes to the device. Only use spare parts and optional accessories sold or recommended by the manufacturer.

Caution: This equipment is not intended for use in residential environments and may not provide adequate protection to radio reception in such environments.

Any other use than that described in this manual is regarded as improper.

Device-specific safety information



Installation inside a control cabinet

If the ISOMETER® is installed inside a control cabinet, the insulation fault message must be audible and/or visible to attract attention.

IT systems with several ISOMETER®s

Only one ISOMETER® may be connected in a galvanically connected system. In IT systems that are interconnected via tie switches, ISOMETER®s that are not required must be disconnected from the IT system or switched to inactive.

If IT systems are coupled via capacitors or diodes, a central control of the various ISOMETER® must be used.

Prevent measurement errors!

In galvanically coupled DC circuits, an insulation fault can only be detected correctly if a minimum current of > 10 mA flows through the rectifiers.

Unspecified frequency range

Depending on the application and the selected measurement profile, continuous insulation monitoring is also possible in low frequency ranges. For IT systems with frequency components above the specified frequency range, there is no influence on the insulation monitoring.

2.2 Device features

Features iso685-x-P

- ISOMETER® for IT AC systems with galvanically connected rectifiers or inverters and for IT DC systems (IT = unearthed systems)
- Automatic adaptation to the existing system leakage capacitance
- Combination of *AMPPLUS* and other profile-specific measurement methods
- Two separately adjustable response value ranges of 1 kΩ...10 MΩ
- Graphical LC display
- Connection monitoring (monitoring of the measuring lines)
- Automatic device self test
- Graphical representation of the insulation resistance over time (isoGraph)
- History memory with real-time clock (buffer for three days) for storing 1023 alarm messages with date and time
- Current or voltage output 0(4)...20 mA, 0...400 μA, 0...10 V, 2...10 V (galvanically separated), which is analogous to the measured insulation value of the system
- Freely programmable digital inputs and outputs
- Remote setting via the Internet or Intranet (web server/option: COMTRAXX® gateway)
- Remote diagnosis via the Internet (made available by Bender Service only)
- isoData: permanent uninterrupted data transmission
- RS-485/BS (Bender sensor bus) for data exchange with other Bender devices via Modbus RTU protocol
- BCOM, Modbus TCP and web server
- ISONet: Internal separation of the ISOMETER® from the IT system to be monitored (e.g. if several IT systems are interconnected)
- ISONet priority: permanent priority of a device within the network
- ISOloop: special function for ring systems (all systems are coupled)
- Locating current injection for selective insulation fault location
- Indication of the insulation faults selectively located by the EDS system
- Parameter setting of EDS systems
- EDSsync: synchronous distribution of trigger information in coupled systems
- Customer-specific texts for each measuring channel

Features EDS44x

- Insulation fault location in AC, 3AC and DC IT systems
- Up to 12 measuring current transformers of the W..., WR..., WS... measuring current transformer series can be connected
- Response sensitivity insulation fault location:
EDS440: 2 ... 10 mA
EDS441: 0.2 ... 1 mA
- Response sensitivity residual current measurement:
EDS440: 0.1...10 A
EDS441: 0.1...1 A
- Communication of the components via BS bus (RS-485) or BB bus

2.3 Product description

General product description

The ISOMETER® is an insulation monitoring device for IT systems in accordance with IEC 61557-8.

It is universally applicable in AC, 3(N)AC, AC/DC and DC systems. AC systems may include extensive DC-supplied loads (such as rectifiers, inverters, variable-speed drives).

Special ISOMETER® characteristics

The ISOMETER® iso685-D-x belongs to the iso685 device family and features an integrated display. This manual applies in full to this ISOMETER®.

The ISOMETER® iso685-S... is the sensor variant of the iso685 device family. The only difference between this variant and the ISOMETER® iso685-D... is that it does not have a display. The ISOMETER® iso685-S... must be used in combination with a front panel through which it is operated. The operation of the front panel is equal to the operation of the ISOMETER® with an integrated display.

i Only the sensor variant (i.e. ISOMETER® iso685-S...) can be connected to the front panel. Connection to the display variant (i.e. ISOMETER® iso685-D...) is not possible.

Hereafter, the ISOMETER®s with integrated display are described. This description is similar to the combination of ISOMETER® sensor variants and the front panel FP200. The devices to which this manual applies will be referred to as ISOMETER®s hereafter.

2.4 Function description

The insulation monitoring device continuously monitors the entire insulation resistance of an IT system during operation and triggers an alarm when the value falls below a preset response value.

For measurement, the device has to be connected between the IT system and the protective earth conductor (PE). A measuring current in the μA range is superimposed onto the system which is recorded and evaluated by a microprocessor-controlled measuring circuit. The measuring time is dependent on the selected measurement profiles, the system leakage capacitance, the insulation resistance and possible system-related disturbances.

The response values and other parameters are set using a commissioning wizard as well as via different setup menus using the device buttons and a graphical LC display. The selected settings are stored in a permanent fail-safe memory. Different languages can be selected for the setup menus as well as the messages indicated on the display. The device utilises a clock for storing fault messages and events in a history memory with time and date stamp. The settings can be password protected to prevent unauthorised changes.

To ensure proper functioning of connection monitoring, the device requires the setting of the system type 3AC, AC or DC and the required use of the appropriate terminals L1/+, L2, L3/–.

To extend the operating range of the nominal voltage, various coupling devices are available as accessories, which can be selected and adjusted via a menu.

The insulation monitoring device iso685... is able to measure the insulation resistance reliably and precisely in all common IT systems. Due to various applications, system types, operating conditions, application of variable-speed drives, high system leakage capacitances etc., the measuring instruments must be able to meet varying requirements in order to ensure an optimised response time and relative uncertainty. Therefore different measuring profiles can be selected with which the device can be optimally adjusted.

If the preset response value falls below the value of Alarm 1 and/or Alarm 2, the associated alarm relays switch, the **ALARM 1** or **ALARM 2** LEDs light, and the measured value is shown on the LC display (in case of insulation

faults in DC systems, a trend graph for the faulty conductor L+/L– is displayed). If the fault memory is activated, the fault message will be stored.

Pressing the **RESET** button resets the insulation fault message, provided that the insulation resistance displayed at the time of the resetting is at least 25 % above the actual response value.

As additional information, the quality of the measuring signal and the time required to update the measured value are shown on the display. A poor signal quality (1-2 bars) may be an indication that the wrong measurement profile is selected.

The ISOMETER® has an internal system isolating switch, which makes it possible to operate several ISOMETER®s in coupled IT systems. For this purpose, the ISOMETER®s are connected via an Ethernet bus. The integrated ISONet function ensures that only one ISOMETER® is actively measuring at any time, while the other devices are completely isolated from the system and waiting in standby mode for measuring permission.

The ISOMETER® is able to synchronise with other ISOMETER®s. This makes it possible to monitor capacitively coupled IT systems without these systems interfering with each other.

2.5 Insulation fault location

An additional function of the ISOMETER® in combination with the EDS is the selective insulation fault location. For this purpose, the ISOMETER® generates a periodic locating current after the measured value has fallen below the set response value R_{an2} (**ALARM 2** LED). Thereby, the system conductors are alternately connected to earth via a defined resistance. The resulting locating current depends on the size of the existing insulation fault and the system voltage. It is limited by the ISOMETER® depending on the settings.

The insulation fault is selectively located by means of the EDS and the measuring current transformer connected to it. The locating current flows from the locating current injector via the live lines to the insulation fault position taking the shortest way. From there, it flows through the insulation fault and the conductor PE back to the ISOMETER®. This locating current pulse is detected by the measuring current transformer on the insulation fault path and signalled by the connected EDS.



CAUTION *Risk of malfunctions due to excessive locating current on sensitive system parts*

The locating current flowing between the IT system and earth can cause controller faults in sensitive parts of the system, such as the PLC or relay.

Ensure that the level of the locating current is compatible with the system to be monitored.

For the duration of the insulation fault location, the function of the insulation monitoring device is deactivated. If during the insulation fault location the locating current falls below the value measurable by the EDS, the insulation fault location is ended by the ISOMETER®.

Compatibility with EDS devices

Device	Article number	Compatibility	BB bus	BS bus	Modbus RTU
EDS440-L, EDS440W-L	B91080202, B91080202W	full		x	
EDS441-L, EDS441W-L	B91080205, B91080205W	full		x	
EDS441-LAB, EDS441W-LAB	B91080207, B91080207W	full		x	
EDS460/490[L/D]		Limited support. Not recommended for new systems		x	
EDS461/491[L/D]				x	
EDS440-S, EDS440W-S	B91080201, B91080201W	full	x		
EDS441-S, EDS441W-S	B91080204, B91080204W	full	x		

EDS195P	B91082040	full			
---------	-----------	------	--	--	--

2.6 Interfaces

- Communication protocol Modbus TCP
- Communication protocol Modbus RTU
- BCOM for communication of Bender devices via Ethernet
- BS bus for communication of Bender devices (RS-485)
- BB bus (Bender backbone bus)
- isoData for recording and managing measured values
- Integrated web server for reading out measured values and setting parameters

2.7 Self test

After the voltage supply has been switched on, the ISOMETER® conducts a self-test during which it automatically and continuously checks all internal measuring functions, the components of the process control such as the data and parameter memory, as well as the connections to the IT system and earth.

The self test can also be activated manually by means of the test button to check the functions of the relays (depending on the configuration) or it can be selected via the **Control** menu (refer to “Control”, page 77).

If the relays are checked during the self-test, they switch for 2 seconds.

The progress of the manual self test is shown on the LC display by a bar graph. Depending on the conditions in the IT system being monitored, the self test is completed after 15...20 seconds. The device then returns to the standard mode (measurement mode), and the currently measured value will be displayed after the measuring time has expired. The display shows the message **Initial measurement** until the first valid value is measured (refer to “Initial measurement”, page 42).

If a fault is detected during the self test, the respective LEDs of the device light (refer to “Alarm messages”, page 110). In addition, the respective message will be indicated on the display and a previously programmed output will provide the respective signal.

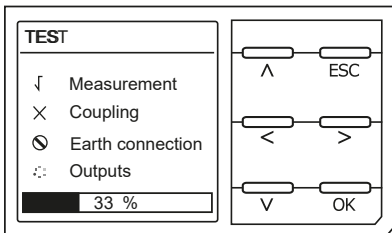

- Test successful
- Test unsuccessful
- Test not available
(e.g. incorrect device settings)
- Testing...

3 Device overview

3.1 Dimensions

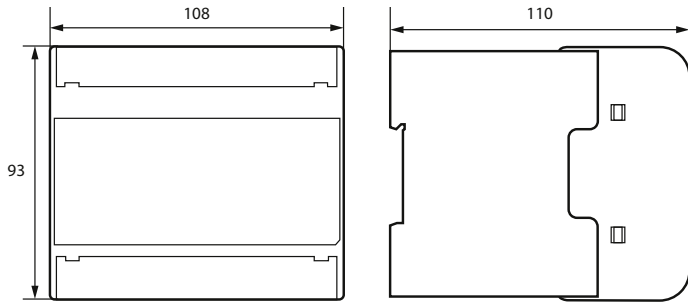
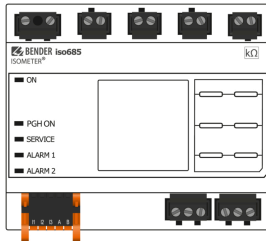

Figure: Enclosure iso685...-device family – dimensions in mm

3.2 Variants

- iso685(W)-D...**, **isoxx685(W)-D...** Graphic LC display and operating controls. Cannot be combined with the FP200(W).



- iso685(W)-S...**, **isoxx685(W)-S...** No display and no operating controls. Can only be operated in combination with the FP200(W).

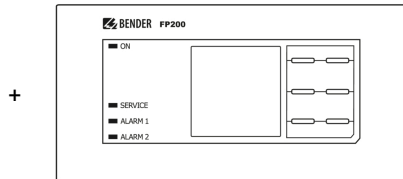
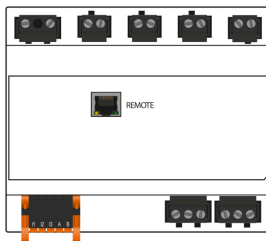

+

3.3 Connection

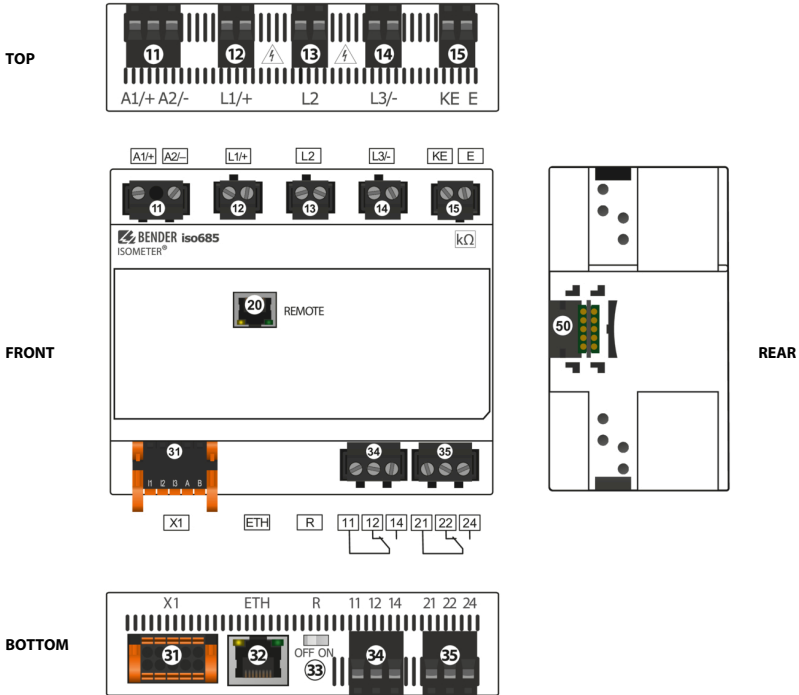

11	A1+, A2-	Connection to the power supply voltage U_s
12	L1+	Connector for the IT system to be monitored
13	L2	Connector for the IT system to be monitored
14	L3-	Connector for the IT system to be monitored
15	KE, E	Connection to PE
20	X4	isoxx685(W)-S... only: connector for the FP200(W)
31	X1	Multifunctional I/O interface
32	ETH (X2)	Ethernet interface
33	R	Switchable terminating resistor for termination of the RS-485 interface
34	11 12 14	Connector for alarm relay 1
35	21 22 24	Connector for alarm relay 2
50	BB-Bus	isoxx685(W)-x-P... only: optional expansion interface for Bender products

i The connection between the iso685 device and an FP200(W) can be interrupted and restored at any time (Plug&Play), but is only recommended in a de-energized state.

3.4 Display elements and device buttons

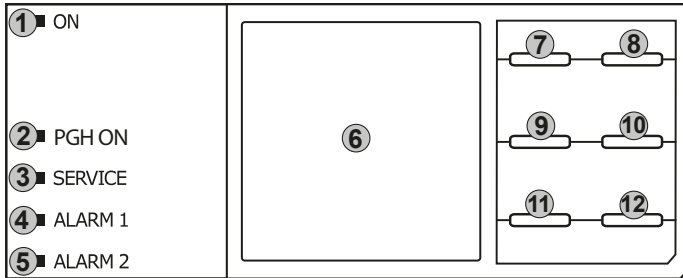

Display elements

1	ON	The ON LED lights when the device is turned on.
2	PGH ON	The PGH ON LED flashes during insulation fault location. It indicates that the locating current for the insulation fault location is generated.
3	SERVICE	The SERVICE LED lights when there is either a device error or a connection fault, or when the device is in maintenance mode.
4	ALARM 1	The ALARM 1 LED lights when the insulation resistance of the IT system falls below the set response value R_{an1} .
5	ALARM 2	The ALARM 2 LED lights when the insulation resistance of the IT system falls below the set response value R_{an2} .
6	Display	The device display shows information regarding the device and the measurements. Further information is available in "Display", page 39.

Device buttons

You can adjust the device settings in the respective menu using the device buttons. Depending on the menu entry, one of the options displayed below is assigned to the buttons.

7	EDS ∧	Manually starts the insulation fault location, which runs continuously. Stops the insulation fault location immediately when it is pressed again. Navigates up in a list or increases a value.
8	MENU ESC	Opens the device menu. Cancels the current process or navigates one step back in the device menu.
9	RESET <	Resets alarms. Navigates backwards (e.g. to the previous setting step) or selects parameter.
10	TEST >	Starts the device self test. Navigates forwards (e.g. to the next setting step) or selects parameter.
11	DATA ∨	Indicates data and values. Navigates down in a list or reduces a value.

12	INFO OK	Shows information. Confirms an action or a selection.
----	--------------------------	--

3.5 Operating and navigating

Menu selection

Activate the menu by pressing the **MENU** button.

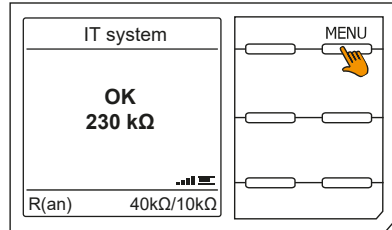

Selection of submenus

Use the and buttons \wedge and \vee to select the options.

Press the button $>$ or **OK** to jump to the next submenu for the selected options.

Exit the menu by pressing the button $<$ or **ESC**.

To return to the start page, press the ESC button for 2 seconds.

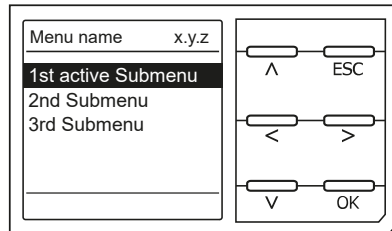

List selection

Use the buttons \vee and \wedge to select values from a predefined list (menu). The present value is indicated by a black menu item. Confirm the value with the **OK** button. Exit the list selection by pressing **ESC**.

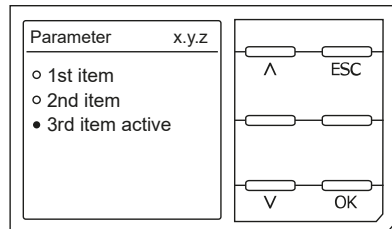

Parameter selection and value adjustment

Use the buttons < and > to select a parameter. The present parameter is highlighted. Values can be changed using the buttons v and ^ . Confirm the value with the **OK** button. Exit the list selection by pressing **ESC**.

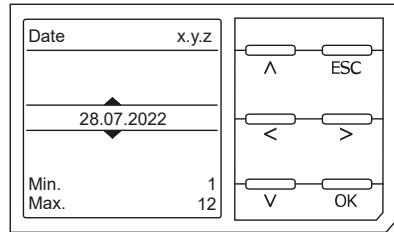

Character input

Use the > (forward) and < (backward) buttons to select a character position on the display. Change a character with the buttons ^ and v .

To delete a character, use the < and > buttons to select the position and then select **del** using the v and ^ buttons.

Confirm the entered text with **OK**. Exit the character input by pressing **ESC**.

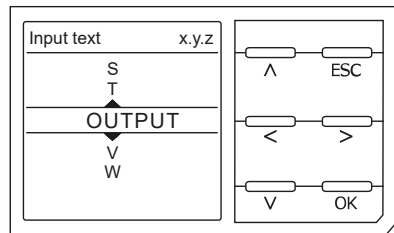

Multiple selection in the device menu

Use the buttons ^ and v to select options (**Select all**, **No selection**, **Invert selection**) and the channels. Confirm the entered text with **OK**.

For the selected channels, press the > button to activate or to jump to the next submenu.

Exit the menu by pressing **ESC**.

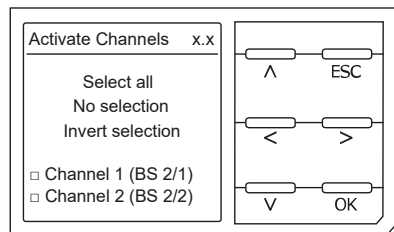

4 Mounting

4.1 General instructions



Only skilled persons are permitted to carry out the work necessary to install, put into service and run a device or system.



ADVICE

Read the operating manual before mounting, connecting and commissioning the device. Keep the manual within easy reach for future reference.



DANGER Risk of fatal injury due to electric shock!

Touching live parts of the system carries the risk of:

- Risk of electrocution due to electric shock
- Damage to the electrical installation
- Destruction of the device

Before installing the device and before working on its connections, make sure that the installation has been de-energised. The rules for working on electrical systems must be observed.

4.2 DIN rail mounting

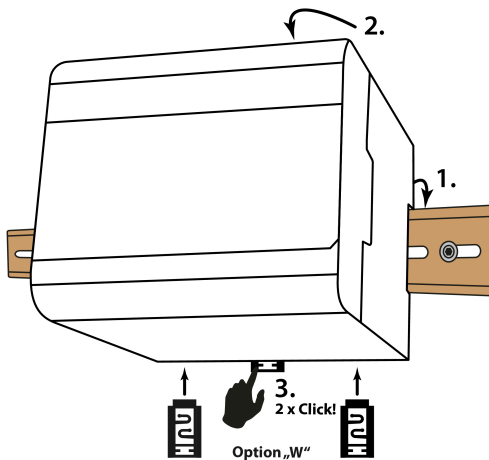

1. Snap the device on the DIN rail.
2. Press the device lightly onto the DIN rail.
3. To fix the device, push the mounting clip into the centre position until it clicks into place. For devices with option **W**, also attach the two separately packed mounting clips.

Figure 4-1: DIN rail mounting

5 Connection

5.1 Connection requirements



Only skilled persons are permitted to carry out the work necessary to install, put into service and run a device or system.



DANGER *Risk of fatal injury due to electric shock!*

Touching live parts of the system carries the risk of:

- Risk of electrocution due to electric shock
- Damage to the electrical installation
- Destruction of the device

Before installing the device and before working on its connections, make sure that the installation has been de-energised. The rules for working on electrical systems must be observed.



DANGER *Electric shock!*

High voltages may be present at the terminals **L1/+** to **L3/-**. Direct contact with these will likely result in electrocution.

- Only operate the device with mounted and locked terminal covers.
- If the terminals **L1/+**, **L2**, **L3/-** of the device are connected to a live IT system, do not disconnect terminals **KE** and **E** from the protective conductor **PE**.
- Connect terminals **KE** and **E** individually to the protective earth conductor **PE**.



WARNING *Injury, fire and damage to property due to a short circuit!*

According to DIN VDE 0100-430, devices used to protect against a short circuit when terminals **L1/+**, **L2** and **L3/-** are coupled to the IT system to be monitored can be omitted if the wiring is designed in such a manner that the risk of a short circuit is reduced to a minimum.

Ensure short-circuit-proof and earth-fault-proof wiring.



CAUTION

Provide line protection!

According to IEC 60364-4-43, a line protection shall be provided for the supply voltage.

Risk of injury from sharp-edged terminals!

Risk of lacerations. Handle enclosure and terminals with care.

Ensure disconnection from the IT system!

When insulation or voltage tests are to be carried out, the device must be isolated from the system for the test period. Otherwise the device may be damaged.

Property damage due to improper installation!

Make sure that only one insulation monitoring device is connected in each conductively connected system. If several devices are connected, the device does not work and does not signal insulation faults. This can damage the installation.

High load currents can result in damage to property and personal injury. Therefore, do not apply any load current to the terminals. The connecting lines **L1/+**, **L2**, **L3/-** to the system to be monitored must be designed as spur lines.

Failure to connect the device as illustrated in the manual leads to deviating technical data and function restrictions.



Check proper connection!

Prior to commissioning the installation, check that the device has been properly connected and check the device functions. Perform a functional test using an earth fault via a suitable resistance.

Prevent measurement errors!

If a monitored AC system contains galvanically coupled DC circuits, the following applies: An insulation fault can only be detected with its correct value when the rectifier valves carry a minimum current of > 10 mA.

For UL applications

Use 60/75 °C copper lines only! For UL and CSA applications, the supply voltage must be protected via 5 A fuses.

5.2 Connection to a 3(N)AC system

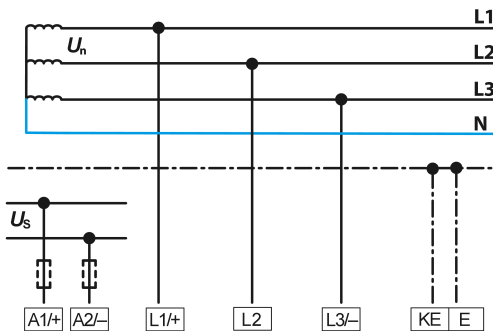

5.3 Connection to a AC system

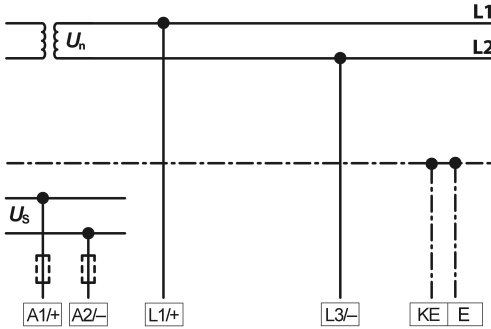

5.4 Connection to a DC system

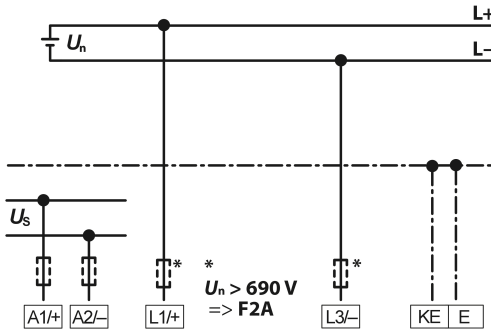

i In systems with a nominal system voltage of more than 690 V and with overvoltage category III, a fuse for the connection to the system to be monitored must be provided. * 2 A fuses recommended.

5.5 Connection to a supply voltage



CAUTION Damage to property due to faulty connection!

The device may be damaged if it is simultaneously connected to the supply voltage via the **X1** interface and via **A1/+** and **A2/-**.

Do not connect the device simultaneously via **A1/+**, **A2/-** and **X1** to different supply voltage sources.

i

Voltage supply via external power supply units

In case of external supply (24 V) the device can be supplied EITHER via **A1/+** and **A2/-** OR via **X1**. In case of supply via **A1/+** and **A2/-**, make sure that +24 V are applied to **A1/+** and that **A2/-** is connected to **GND** (ground).

Back-up fuse for voltage supply

If the device is supplied via an external power supply unit, the back-up fuse $F_{back-up}$ at connection **A1/+**, **A2/-** must be selected so that the feeding power supply unit is able to trip the DC-compatible back-up fuse. Example: A back-up fuse of 650 mA/T is recommended when using a 24 V power supply unit (min. 1 A).

Emission requirements for external voltage supply

External power supply units that supply the ISOMETER® via **X1** must meet the immunity and emission requirements of the relevant application standard. For connecting cables longer than 1 m, shielded cables must be used.

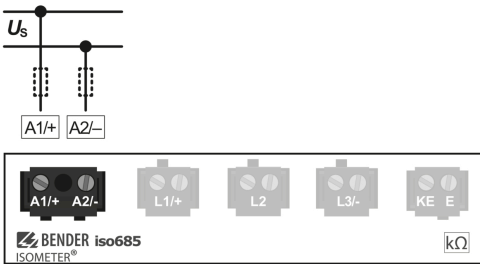

5.6 Connection to the X1 interface

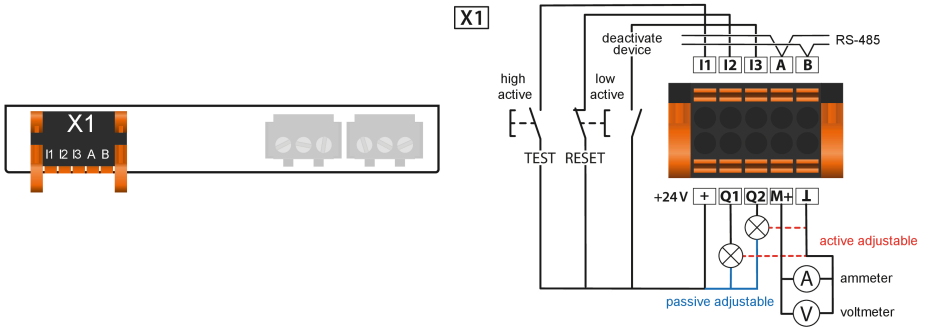

I1...I3 (X1)	Configurable digital inputs (e.g. test, reset, ...)
A, B (X1)	Serial interface RS-485, termination by means of a DIP switch R.
+ (X1)	Supply voltage of the inputs and outputs I, Q and M. Electrical overload protection. Automatic shutdown in the event of short circuits and transients (resettable). When supplied via an external 24 V source, A1/+, A2/- must not be connected.
Q1, Q2 (X1)	Configurable digital output
M+ (X1)	Configurable analogue output (e.g. measuring instrument)
⊥ (X1)	Reference potential ground

5.7 Connection to the Ethernet interface ETH

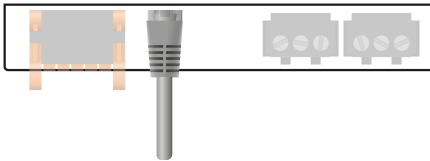

Connection with standard patch cable (RJ45/no crossover cable) to other ISOMETER®s or interconnection of several ISOMETER®s in star topology via a switch.

5.8 Connection of the relay interfaces 1 and 2

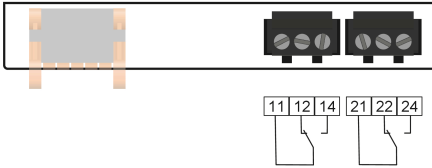

Relay 1	11 common contact	12 N/C contacts	14 N/O contacts
Relay 2	21 common contact	22 N/C contacts	24 N/O contacts

5.9 Terminal covers

Insert the terminal covers into the recesses provided in the enclosure until they click into place.

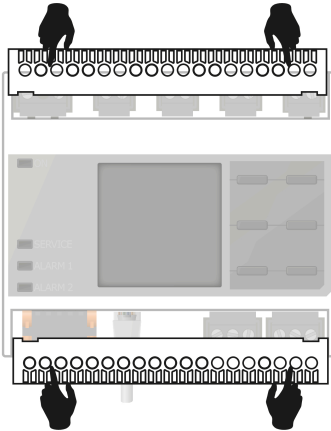

5.10 Connection to the BB bus

The BB bus is an interface that enables Bender devices to communicate with each other. The BB bus can be used with an ISOMETER® and one or more EDS44x-S. For this purpose, the BB bus is installed at the rear side of both devices and afterwards, both devices are mounted next to each other on the DIN rail. For further information, refer to the quickstart guide enclosed to the BB bus PCBs.

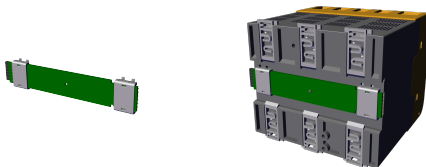

i If the ISOMETER® is combined with an EDS44x-S, the **BB bus 6TE plug connection** must be ordered additionally. Sensor variant devices that are additionally connected to the ISOMETER® do not require additional supply voltage when the devices are connected to the BB bus via X3. A maximum of two EDS44x-S or one EDS and one IOM441 each can be connected to an ISOMETER®. When the BB bus is installed, the EDS44x/IOM441 must always be mounted on the right side of the ISOMETER®. In addition, for protection against short circuits, a BB bus end bracket must be mounted to each first and last device on the DIN rail featuring a BB bus.

Observe the maximum output current!

The following applies to devices connected to the BB bus: The maximum output current is reduced according to the formula for calculating I_{LmaxX1} . You can find the formula at Inputs/outputs (X1) in section Tabular data iso685-x-P-B.

5.11 Connection of EDS44x/IOM441 to the ISOMETER®

A maximum of 50 EDS44x devices with one IOM44 each can be connected to an ISOMETER®. If one EDS and one IOM each are connected via the BB bus, another 49 EDS44x devices can be connected to the corresponding IOM441 via the RS-485 interface.



CAUTION Malfunctions due to excessive locating current

The locating current flowing between the IT system and earth can cause controller faults in sensitive parts of the system, such as the PLC or relay.

Ensure that the level of the locating current is compatible with the system to be monitored.



CAUTION Incorrect measurement

The supplied locating current may influence other connected insulation fault location systems. If they measure the injected locating current, the measurement might be incorrect.



Insulation monitoring is deactivated while the insulation fault location is active.

The **EDS44x-S** must be connected to the ISOMETER® via **BB bus**.

The **EDS44x-L** must be connected to the ISOMETER® via **RS485/BS bus**.

Connection EDS44x and iso685-x-P to an AC system

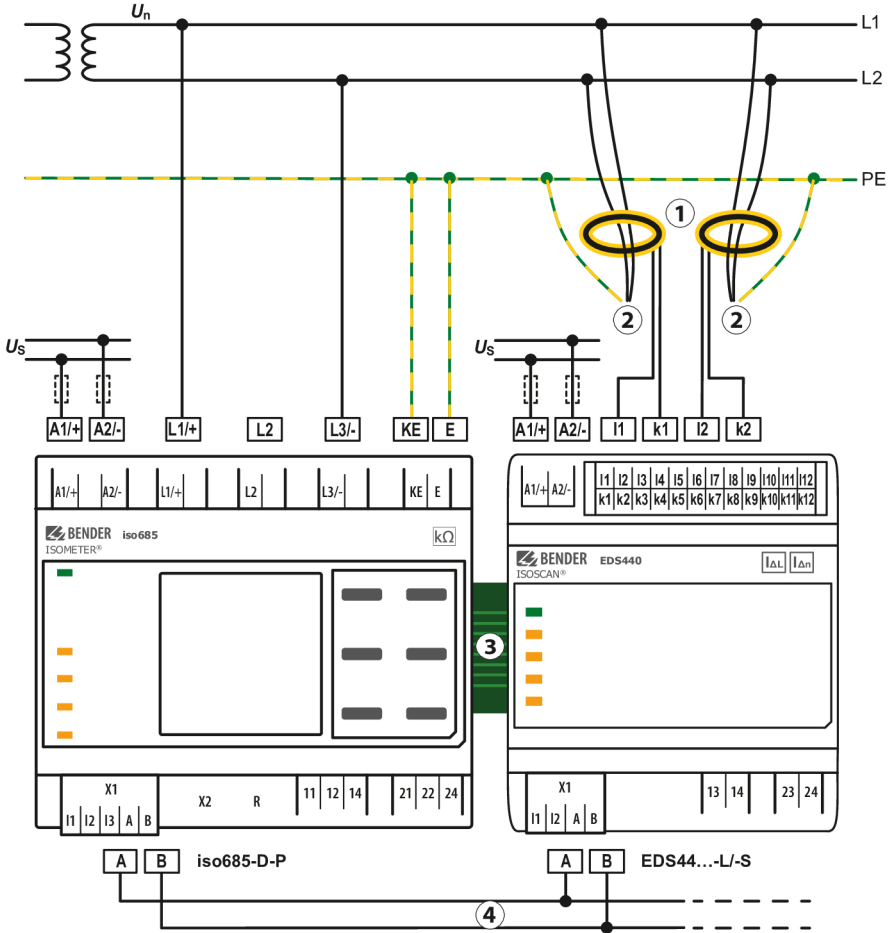

- 1 Measuring current transformers
 - 2 to the loads
 - 3 BB bus for communication to and supply of EDS44...-S
 - 4 BS bus for communication from iso685(W)-...-P to EDS44...-L
- U_s Connection of the supply voltage only to EDS44...-L

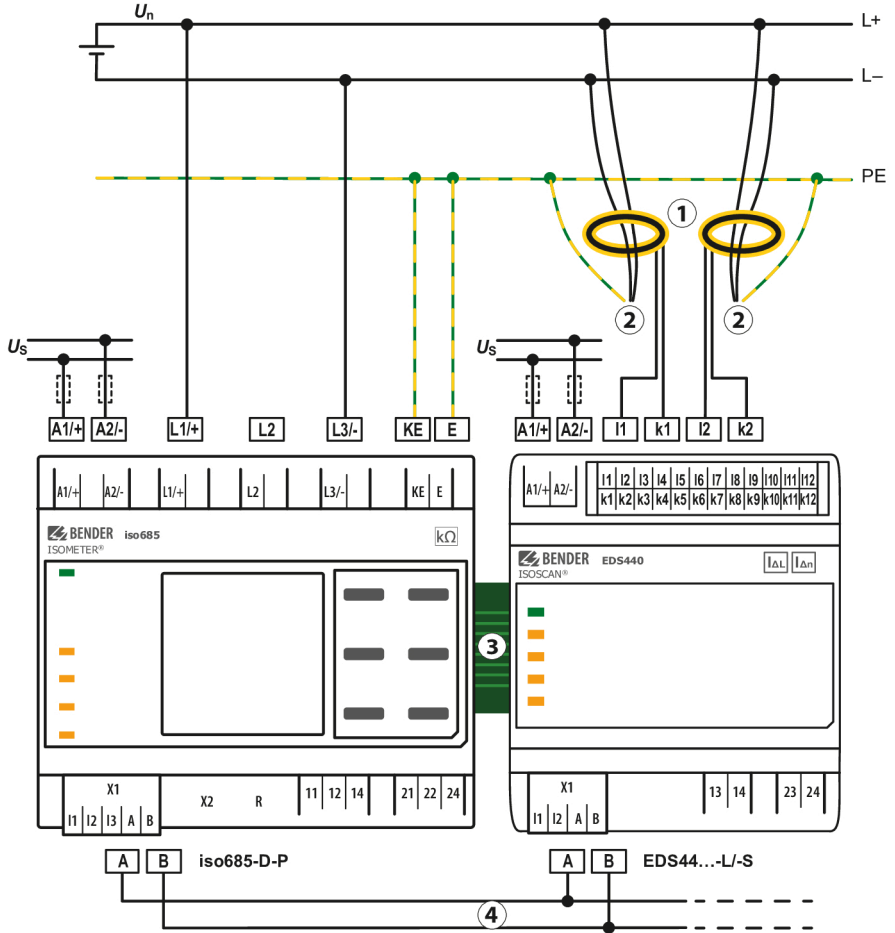
Connection EDS44x and iso685-x-P to a DC system

- 1 Measuring current transformers
 - 2 to the loads
 - 3 BB bus for communication to and supply of EDS44...-S
 - 4 BS bus for communication from iso685(W)-...-P to EDS44...-L
- U_s Connection of the supply voltage only to EDS44...-L

System structure

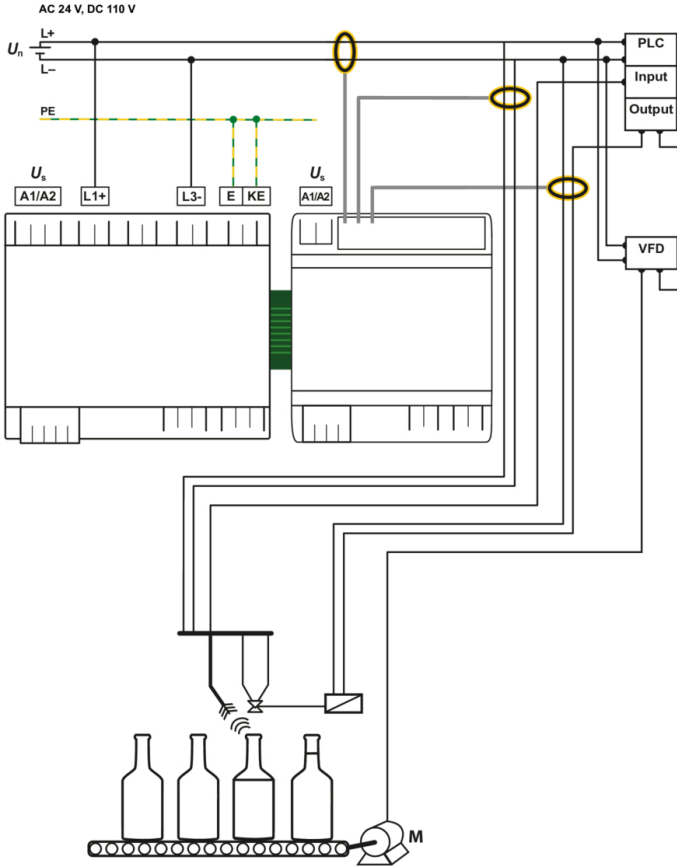

Connection iso685-x-P with EDS44x and IOM441

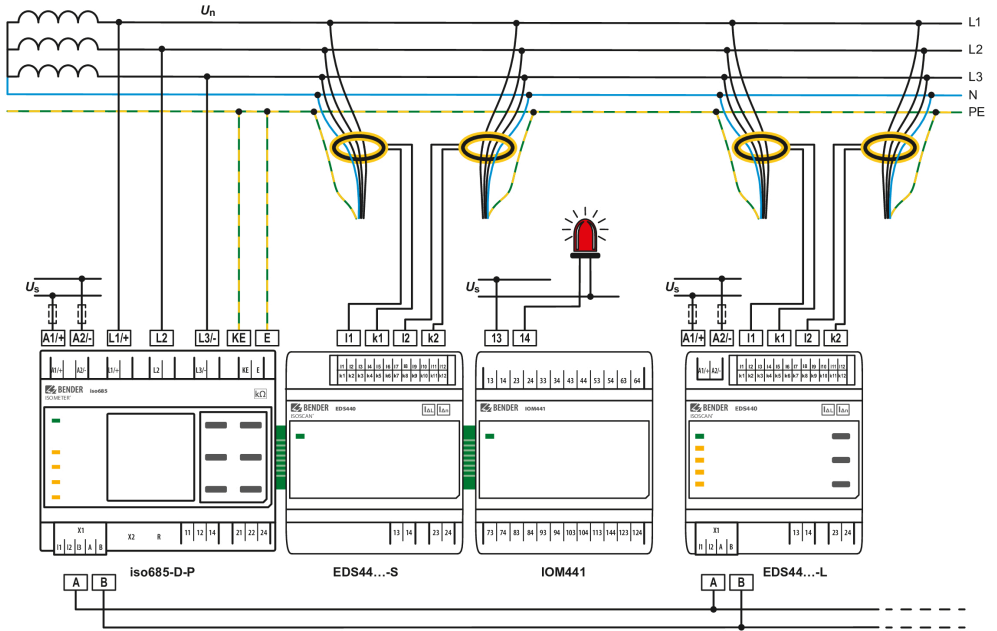

6 Commissioning

6.1 General commissioning process

1. Check that the ISOMETER® is properly connected to the system to be monitored.
 2. Connect the supply voltage to the ISOMETER®.
 3. Set the device via the commissioning wizard.
- ✓ The ISOMETER® performs a self test in four steps. The alarm relays are not checked during this test. The measured insulation resistance is shown on the display. If the value exceeds the response values indicated in the lowest line of the display, the message **OK** will additionally be displayed.



For customer-specific configured devices, the commissioning wizard might be deactivated and cannot be run. In this case, the device is preset. However, the commissioning wizard can be started as described at "Recommissioning", page 37 below.

4. Check the ISOMETER® in the system being monitored, e.g. using a suitable resistor to earth.



Observe the device status! *The device is in an alarm state until initial commissioning has been completed.*

Commissioning procedure, iso685-x-P with EDS44x

	ISOMETER® commissioning	EDS44x commissioning	ISOMETER® with EDS44x commissioning
1	Connect device according to wiring diagram and device documentation.	Connect device and measuring current transformer according to wiring diagram and device documentation.	Switch off supply voltage of all devices.
2	Switch on supply voltage.	Switch on supply voltage.	Connection of EDS to ISOMETER® * EDS44x-L: via BS bus * EDS44x-S: via BB bus
3	Switch on mains voltage.	The ON LED flashes during power up until the device is ready for operation.	Switch on the supply voltage of all devices.
4	Run the commissioning wizard.	Set BS address with the ADDR button on the EDS44x-L. Display by channel LEDs.	Set EDS mode in the ISOMETER® menu EDS > General > Mode.
5	Self test of the ISOMETER®	Eliminate all possible device errors in accordance with the device documentation.	Search for configurable measuring channels in the ISOMETER® menu EDS > Scan channels.
6	Functional test with suitable resistor from system to earth, size: 50 % of the Alarm 2 response value	The EDS44x is fully functional and correctly connected..	Activate measuring channels in the ISOMETER® menu EDS > Activate channel.
7	Remove resistor.	CT connection test is carried out every 10 minutes. Indication by means of flashing ON LED.	Set max. locating current in the ISOMETER® menu EDS > General > Current * EDS440x: 10...50 mA * EDS441x: 1...5 mA
8	Set BS address = 1 Master (corresponds to factory setting).		Make settings for the EDS44x in the ISOMETER® menu EDS.
9	If necessary, adjust group settings.		Functional test with suitable resistor from system to earth. Size: 50 % of the Alarm 2 response value
10	The ISOMETER® is fully functional and correctly connected.		Remove resistor.
11			ISOMETER® and EDS44x are fully functional and correctly connected.

6.2 Initial commissioning

i **Check network function!**
 When the device has been integrated into a network, the influence on the network has to be checked with the device switched on and off.

Follow the instructions of the commissioning wizard on the display.

Setting the language

The language selected here will be used in the menu and for device messages.

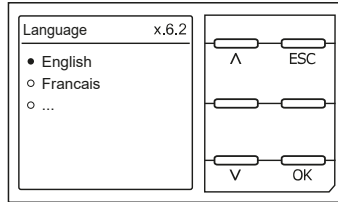

Setting date and time

Alarm messages in the history memory and the insulation resistance value over time can only be assigned correctly to the isoGraph when date and time are set correctly.

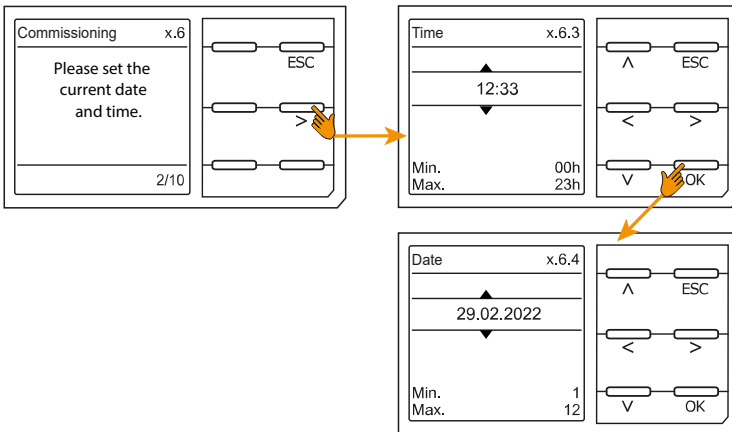

Setting system type

When the system type is set, the insulation monitoring device is optimally adapted to the system to be monitored. The system type is essential information for the insulation monitoring device in order to determine the insulation resistance correctly.

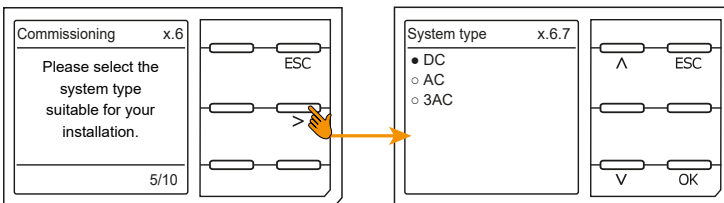

Setting the profile

In order to optimally adapt the insulation monitoring device to the system to be monitored, you can select a profile here that is suitable for your installation. For an overview of the available profiles refer to “Technische Daten”, page 113. The **Power circuits** profile is suitable for most of the IT systems.

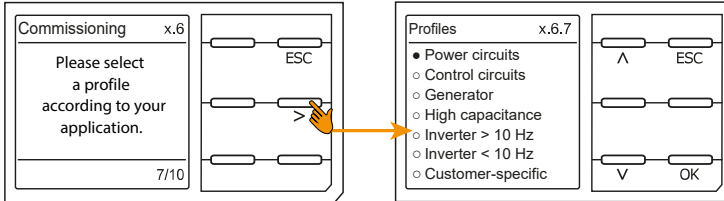

Setting EDS mode

Set the mode for the insulation fault location to **Manual, Automatic** or **1 cycle**.

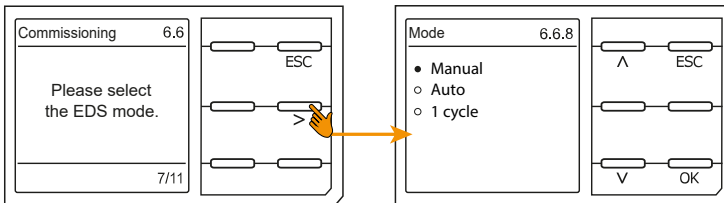

Setting EDS current

Set the maximum locating current.

- EDS441: 1-5 mA
- EDS440: 10-50 mA

For more information see “Current”, page 60.

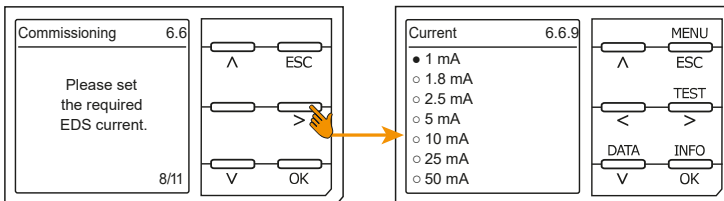

Setting response value R_{an1} for Alarm 1

You can set the prewarning response value here. A value of 100 Ω/V is recommended for the prewarning.

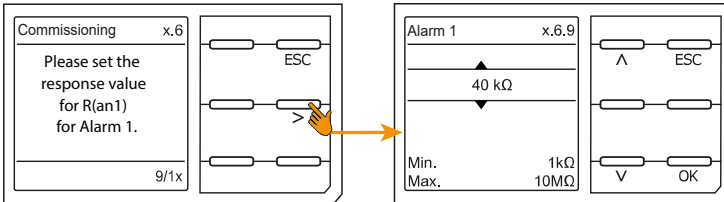

Setting response value R_{an2} for Alarm 2

You can set the response value for the main alarm here. A value of 50 Ω/V is recommended for the main alarm.

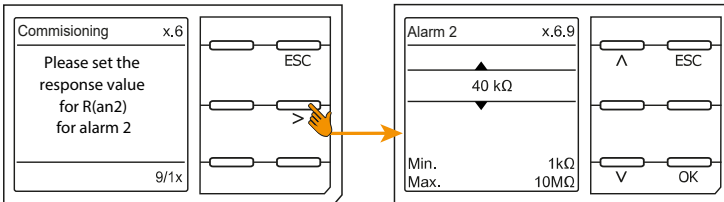

After setting the response value R_{an2} for alarm 2, the device starts a self test, makes the initial measurement and outputs the measured insulation resistance values of the IT system being monitored, then commissioning is completed.

6.3 Commissioning an EDS

Proceed as follows to put into operation an EDS after commissioning the ISOMETER®:

1. First, search for all available measuring channels.

MENU: EDS > Scan channels

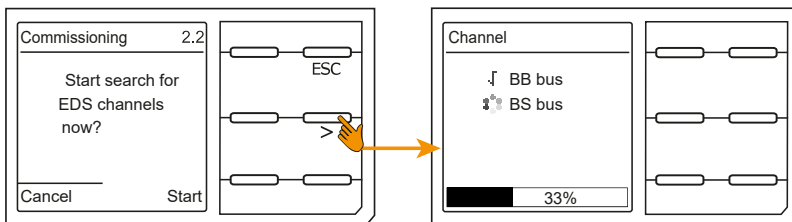

2. Activate all or only selected measuring channels. To this end, select the required menu item, confirm your selection with **OK** and start activation with **>**. Wait until the process is completed.

MENU: EDS > Activate channel

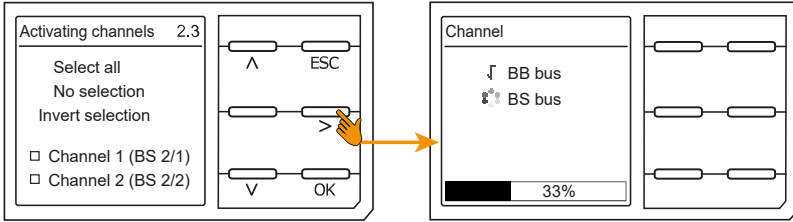

3. Check whether the maximum locating current is correct for the respective EDS variant. Adjust it, if necessary. Wait until the process is completed. See “Current”, page 60.

MENU: EDS > General > Current

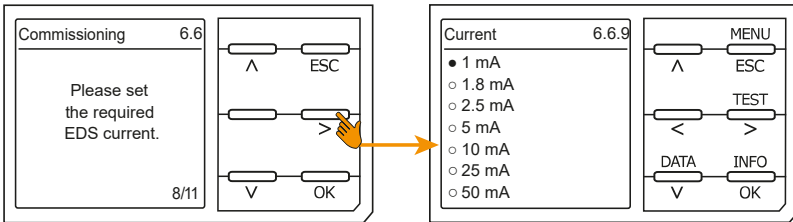

6.4 Recommissioning

If the device has already been put into operation once, the self test will be carried out shortly after the supply voltage has been connected. The commissioning wizard will not restart. You can restart the commissioning wizard in the menu:

MENU: Device settings > Commissioning

This menu can be used to modify settings made previously.

6.5 Configuring password protection

You can assign a password in the device menu.

- Select device menu:
MENU: Device settings > Password
- Activate the password in submenu **Status** by selecting the setting **on**.
- Set a four-digit password in submenu **Password**. You can use the digits 0 to 9.

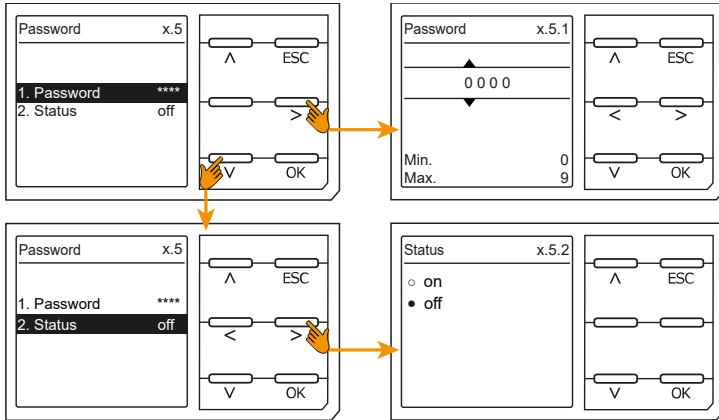

7 Display

7.1 Standard display

During normal operation, the ISOMETER® displays the message **OK** and below, the currently measured insulation resistance.

	The signal quality of the measurement is suitable for the selected profile The better the signal quality, the faster and more exact the device can measure.
	The signal quality of the measurement is not suitable for the selected profile Select a different measurement profile. (See "Device profiles", page 115)
	Progress bar between two measuring pulses

The set response values for R_{an1} and R_{an2} are shown in the bottom row of the display. In the example below, $R_{an1} = 40 \text{ k}\Omega$ and $R_{an2} = 10 \text{ k}\Omega$.

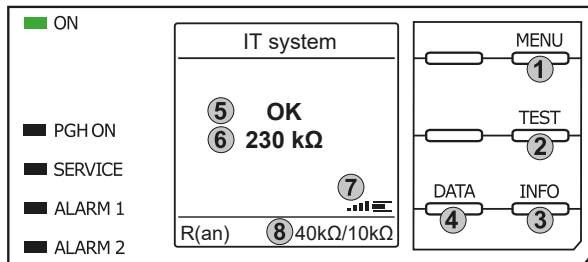

Keypad

1. Menu selection
2. Start Test
3. Device information
4. Measuring data displayed as graph

Display

5. System state
6. Currently measured value
7. Signal quality and progress bar
8. Currently set values for prewarning and main alarm

7.2 Fault display (active)



An active fault is displayed by the general warning sign. The upper part of the display turns orange and displays the fault message.

Depending on the type of fault, the LEDs **ALARM 1**, **ALARM 2** or **SERVICE** are activated.

In the following example, a resistance has been detected. Since the values $R_{an1} = 40 \text{ k}\Omega$ and $R_{an2} = 10 \text{ k}\Omega$ are both below the set response value, **ALARM 1** and **ALARM 2** have been triggered.

If several fault messages have appeared, you can navigate through the faults using the ∇ and \wedge buttons.

If the value falls below R_{an1} in a DC system or a DC offset is detected in an AC system, additional detailed information regarding the DC offset will be displayed.

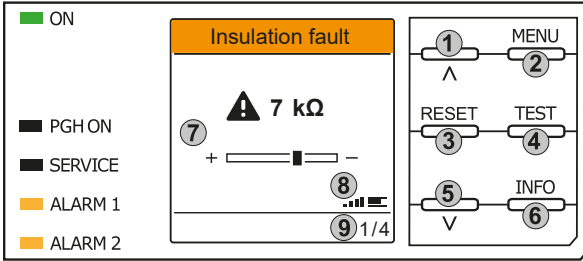

Keypad

1. Previous fault
2. Menu selection
3. Acknowledge fault
4. Start test
5. Next fault
6. Device information

Display

7. Display of fault value and DC offset
8. Signal quality and progress bar
9. xth fault of

7.3 Fault display (inactive)



An inactive fault is displayed by an encircled **i**. If several faults have occurred, the number of faults will also be indicated.

The message shown on the display means that there has been a fault in the past but the device is no longer in active fault condition.

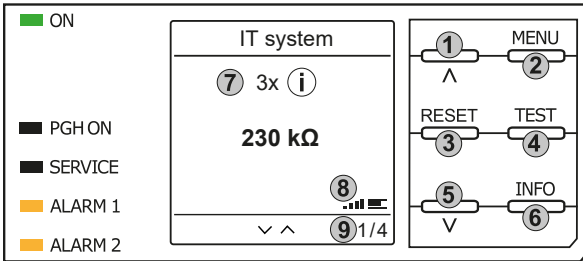

Keypad

1. Previous fault message
2. Menu selection
3. Acknowledge fault
4. Perform manual device test
5. Next fault message
6. Device information

Display

7. Fault number /fault message count
8. Signal quality & measuring pulses
9. Number of the selected fault/Fault message count

If several fault messages have occurred, navigate through the faults using the **V** and **^** buttons. In addition to the type of fault and the associated alarm value, you can see when the fault has occurred and how long it has been active.

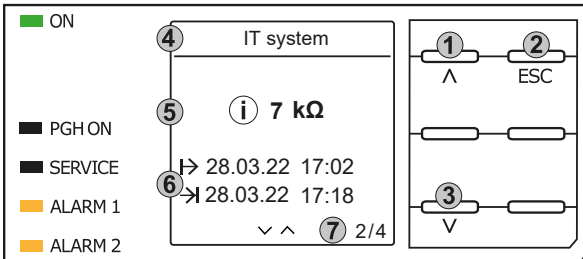

Keypad

1. Previous fault message
2. Exit view
3. Next fault message

Display

4. Fault description
5. Alarm value
6. Fault appeared / fault disappeared
7. Number of the selected fault/Fault message count

7.4 Acknowledging a fault message

In order to acknowledge the fault message and return to the ISOMETER®'s standard display, all faults must be acknowledged by means of the **RESET** button.

This means that fault messages can only be reset when the cause of fault has been eliminated.

Press the **RESET** button, then **>** and **OK** to clear the fault memory. The ISOMETER® then returns to the standard display.

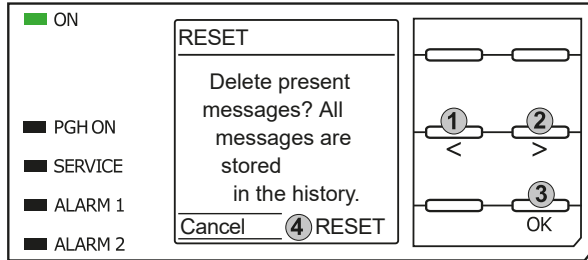

Keypad

1. Select Cancel.
2. Select RESET.
3. Confirm function.

Display

4. Functions Cancel / Reset

7.5 History memory

Up to 1023 alarm messages and device errors are stored in the history memory with date and time stamp. If the history memory is deleted, the minimum insulation resistance R_{\min} will also be reset in the isoGraph data at:

MENU: Data > Measured values > Data - isoGraph

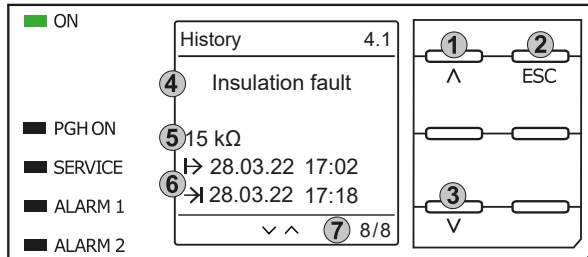

Keypad

1. Next message
2. Exit view
3. Previous message

Display

4. Fault description
5. Alarm value
6. Fault appeared / fault disappeared
7. Number of the selected fault/Fault message count

7.6 Data - isoGraph

The isoGraph represents the chronological sequence of the insulation resistance over time. This graphical representation can be displayed over the following time periods: hour, day, week, month and year. The measured values for individual representations are stored in a separate memory. Up to 100 measured values are available to show each graph on the display, and the resolution of each graph is determined by these values.

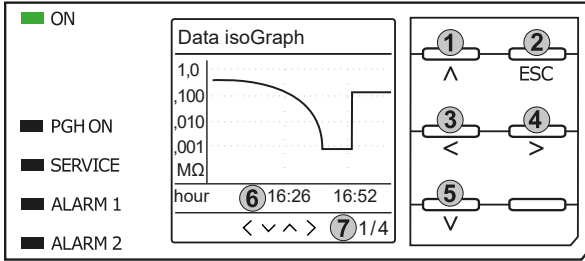

Keypad

1. Switch to previous measured value overview
2. Exit view
3. Change scaling (zoom in)
4. Change scaling (zoom out)
5. Switch to next measured value overview

Display

6. Present time scaling
7. xth view of ...

7.7 Start initial measurement

During the initial measurement, the device records all measured values.

All measured values that may have been recorded before will be discarded if a new initial measurement is started.

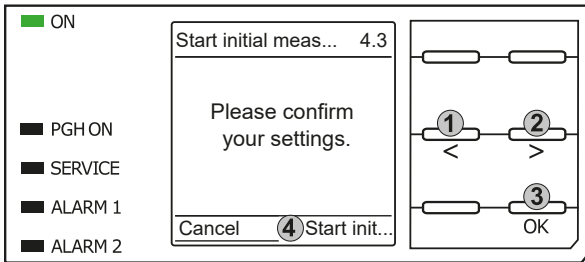

Keypad

1. Select cancel
2. Select function
3. Confirm

Display

4. Cancel | Start initial measurement

7.8 ISOnet operation

The ISOMETER® displays the message **ISOnet active** when the ISOMETER® is in ISOnet mode but is not currently measuring.

The **ON** LED lights up permanently and the measurement progress bar does not pulse.

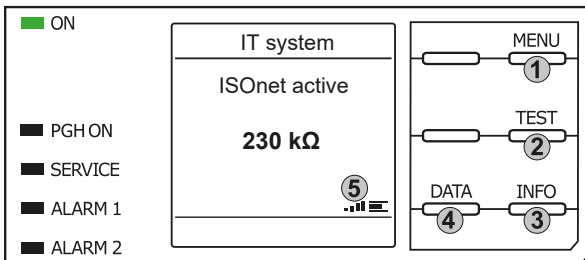

Keypad

1. Menu selection
2. Start Test
3. Device information
4. Graphical representation

Display

5. Signal quality and progress bar

7.9 ISOloop

The ISOMETER® shows the message **ISOloop active** in the display when the ISOMETER® is in ISOloop mode. The **ON** LED lights up permanently.

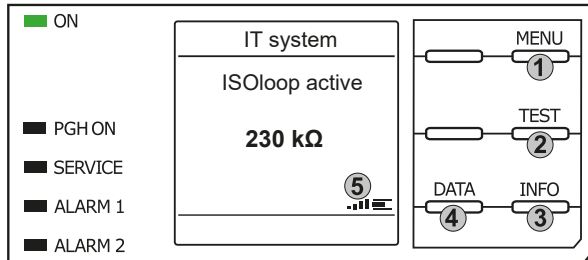

Keypad

1. Menu selection
2. Start Test
3. Device information
4. Display of the insulation level as a graph

Display

5. Signal quality and progress bar

7.10 Automatic test

First, the ISOMETER® performs an automatic test. During the test, the connections to the IT system and to earth are tested. Afterwards, the ISOMETER® performs an initial measurement and records all measured values in the device (see also "Start initial measurement", page 42).

The ISOMETER® then measures during one measuring cycle before passing on the authorisation for insulation measurement to the ISOMETER® with the next higher address.

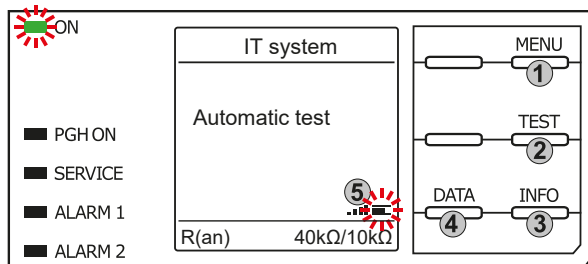

Keypad

1. Menu selection
2. Start Test
3. Device information
4. Display of the insulation level as a graph

Display

5. Signal quality and progress bar

If the ISOMETER® measures in ISONet mode, the **ON** LED flashes and the measurement progress bar in the lower right corner pulses.

7.11 Insulation fault location

When EDS mode is activated, the ISOMETER® indicates the message **Ins. fault locat.**. Below, on the left side it indicates which EDS mode is activated. On the right side, it indicates the polarity change of the measuring pulses including the pause in between. The different pulse phases are indicated by the corresponding symbols.

	Positive measuring pulse
	Pause
	Negative measuring pulse
	The insulation fault location has been started manually and runs continuously. No insulation measurement takes place.
43 s	Insulation fault location in auto mode and 1 cycle . Time countdown of a measurement cycle.
---	Time cannot be indicated.

i **Display for low-frequency measurements**

In the LAB procedure, the pulse can last up to one minute. Therefore, there is no constant changing of the display symbols. The respective symbols are displayed continuously for the pulse time of up to 1 minute.

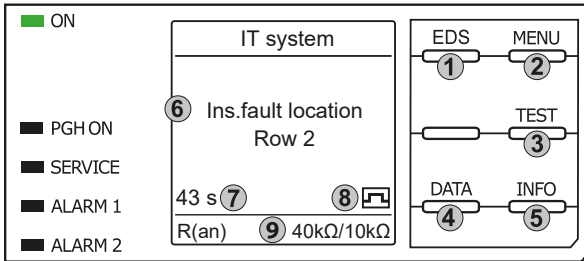

Keypad

1. Start EDS
2. Menu selection
3. Start Test
4. Display of the insulation level as a graph
5. Device information

Display

6. Function name
7. 43 s: Insulation fault location in **auto** mode and **1 cycle**.
∞s: Insulation fault location has been started manually.
8. Measuring pulse phase
9. Response values for prewarning and main alarm

When an insulation fault is detected, the display switches to fault mode. When a fault is active, the header is highlighted in orange; the number of faults present and the ongoing insulation fault location are displayed.

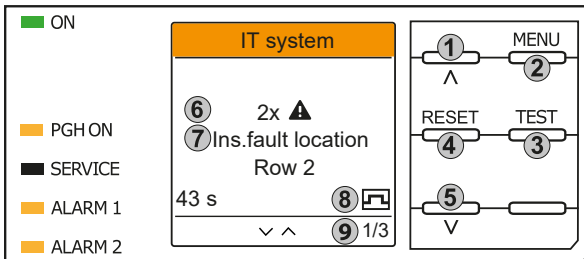

Keypad

1. Previous fault
2. Menu selection
3. Start Test
4. Acknowledge fault
5. Next fault

Display

6. Number of faults
7. Fault indication
8. Measuring pulse phase
9. xth fault of ...

8 Settings in the device menu

8.1 Menu structure

1. Alarm settings		
	1. Insulation alarm	<ul style="list-style-type: none"> 1. Alarm 1 2. Alarm 2 3. Fault memory
	2. DC alarm	<ul style="list-style-type: none"> 1. Alarm 2. U(DC-E)
	3. Profile	
	4. System type	
	5. ISOnet	<ul style="list-style-type: none"> 1. ISOnet 2. Number of devices
	6. ISOloop	<ul style="list-style-type: none"> 1. ISOloop 2. Number of devices
	7. t(start)	
	8. Coupling monitoring	
	9. Behaviour when inactive	<ul style="list-style-type: none"> 1. Initial value 2. Keep state
	10. Inputs	<ul style="list-style-type: none"> 1. Digital 1 2. Digital 2 3. Digital 3
	11. Outputs	<ul style="list-style-type: none"> 1. Relay 1 2. Relay 2 3. Digital 1 4. Digital 2 5. Buzzer 6. Analogue
2. EDS		
	1. General	<ul style="list-style-type: none"> 1. Current 2. Mode 3. Using a portable EDS 4. EDSsync 5. Scan channels
	2. Scan channels	
	3. Activating channels	
	4. Group settings	<ul style="list-style-type: none"> 1. Channel selection 2. Outputs 3. Digital input 4. Device settings

5. Channel	<ol style="list-style-type: none"> 1. Name 2. CT monitoring 3. I(ΔL) response value 4. I(Δn) response value
6. Outputs	<ol style="list-style-type: none"> 1. Common relays 2. Channel relays 3. Buzzer 4. Digital input
7. Inputs	<ol style="list-style-type: none"> 1. Mode 2. t(on) 3. t(off) 4. Function
8. Device	<ol style="list-style-type: none"> 1. Name 2. Trigger 3. Fault memory
9. Service	
3. Data meas. values	
4. Control	<ol style="list-style-type: none"> 1. TEST 2. Reset 3. Initial measurement 4. EDS 5. Device 6. ISONet priority
5. History (only Delete protected)	
6. Device settings	<ol style="list-style-type: none"> 1. Language 2. Clock (& Date) 3. Interfaces 4. Display 5. Password 6. Commissioning 7. Data backup 8. Approve 9. Factory settings 10. Software 11. Service
7. Info	

8.2 Settings

8.2.1 Alarm settings

The limit values for the insulation resistances of Alarm 1 and Alarm 2 can be specified in the alarm settings menu and can be adapted to the user profile of the ISOMETER®. A device password is required for entering the settings.

8.2.1.1 Insulation alarm

In the **Insulation alarm** menu, the ISOMETER® limit values for **Alarm 1** and **Alarm 2** can be set.

Activation and deactivation of the two alarm levels R_{an1} for **Alarm 1** and R_{an2} for **Alarm 2** are illustrated in the following graphic.

An alarm will become inactive as soon as the hysteresis of the set operating value is exceeded.

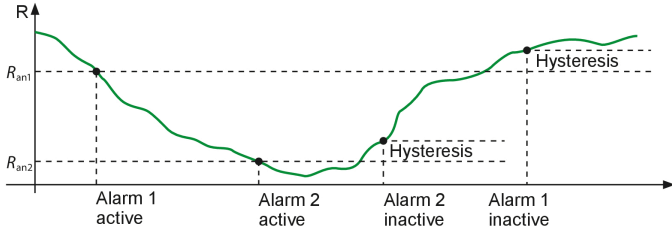

Menu item: Alarm 1

For **Alarm 1** an insulation resistance of 1 k Ω ...10 M Ω can be set independently of **Alarm 2**.

Menu item: Alarm 2

For **Alarm 2** an insulation resistance of 1 k Ω ...10 M Ω can be set independently of **Alarm 1**.

Menu item: Fault memory

Automatic reset of inactive faults at the outputs relay 1, relay 2, digital output 1, digital output 2:

- on** If a fault becomes inactive, the programmed outputs remain in fault condition until the system is reset manually.
- off** If a fault becomes inactive, the programmed outputs automatically change their state.

8.2.1.2 DC alarm

The DC alarm is triggered in the event of a DC offset voltage U_{DC-E} in the system.

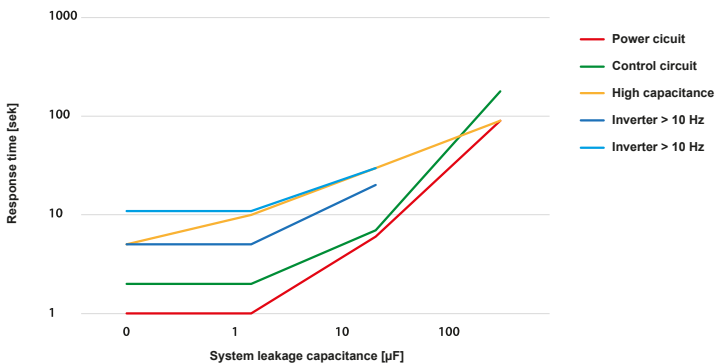

Menu item: Alarm

- on** The DC alarm is triggered in the event of a DC offset voltage.
off The DC alarm is NOT triggered in the event of a DC offset voltage.

Menu item: U(DC-E)

Set the DC alarm to a value between 20 V and 1 kV.

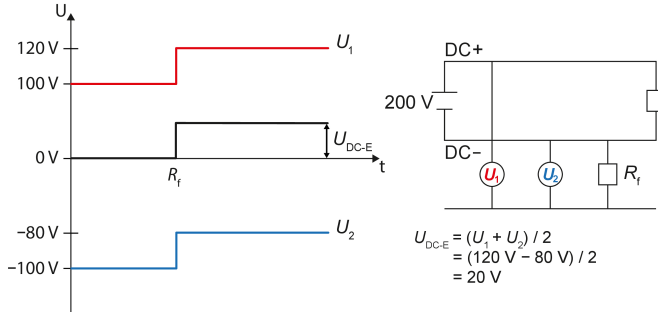

8.2.1.3 Profile

Adapt the area of application of the ISOMETER® to your system profile. For a description of the profiles refer to “Device profiles”, page 115.

The following can be selected:

Power circuits	Suitable for most IT systems.
Control circuits	Not recommended for voltages > 230 V.
Generator	Fast measuring times, fast fault location possible.
High capacitance	Suitable for systems with high system leakage capacitances.
Inverter >10 Hz	Suitable for systems with dynamic frequency control by inverters in the range 10...460 Hz.
Inverter <10 Hz	Suitable for systems with extremely low frequency controls in the range 0.1...460 Hz.
Customer-specific	Enables the Bender service to make customer-specific settings.

8.2.1.4 System type

Adapt the ISOMETER® to the IT system to be monitored. The following can be selected:

DC	Direct current system
AC	Single-phase AC system
3AC	Three-phase AC system

8.2.1.5 ISONet

Make the settings to use the ISONet function.

The ISONet function ensures via the Ethernet connection that only one ISOMETER® of the interconnection is active when several ISOMETER®s are connected to an IT system. For further information regarding the ISONet function, refer to “System isolation via ISONet”, page 97.

Menu item: ISOnet

Activate or deactivate the ISOnet function.

- off** The ISOnet is deactivated
BCOM The ISOnet function is activated via BCOM

Menu item: Number of devices

Configure the number of devices (2...20) in a subsystem.

8.2.1.6 ISOloop

You can activate or deactivate the ISOloop function:

- ISOloop
- Measured value subscription

Menu item: ISOloop

You can turn the ISOloop function on or off.

Menu item: Measured value subscription

When the measured value subscription and the ISOloop function are activated, the measured values of the active measuring device are distributed within the team and shown on all displays. See also chapter 11.4, ISOloop.

8.2.1.7 t(start)

The start-up delay t_{start} delays the start of the ISOMETER®'s first initial measurement.

Setting range: 0...600 s

8.2.1.8 Coupling monitoring

The ISOMETER® continuously monitors the coupling of energised systems. The coupling of deenergised systems is monitored at 8 hour intervals. This monitoring function can be activated or deactivated.

- on** Coupling monitoring is activated.
off Coupling monitoring is deactivated.

8.2.1.9 Behaviour when inactive

This menu item controls the behaviour of the device once it has been set to inactive.

- Initial value** When the device becomes inactive, the maximum measured value of the measuring range is displayed and all insulation faults are reset.
Keep state When the device becomes inactive, the maximum measured value and the insulation faults that were present at the time of the device deactivation are displayed.

8.2.1.10 Inputs

The ISOMETER® provides a total of three digital inputs.

The wiring diagram shows in an exemplary manner how the digital inputs can be wired.

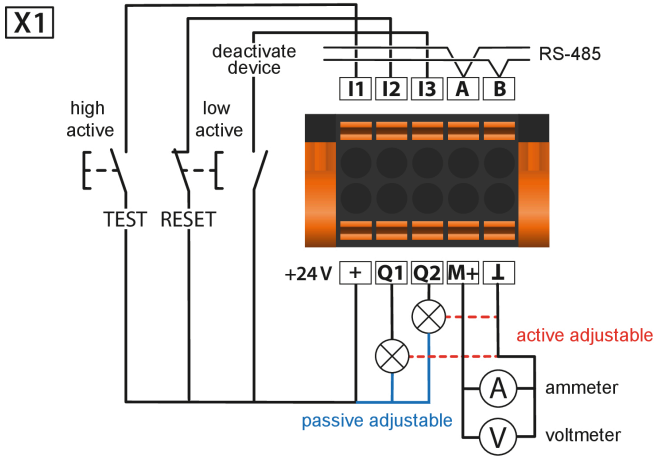

8.2.1.10.1 Digital inputs 1 to 3

The following parameters are available for the configuration of the digital inputs 1 to 3.

Menu item: Mode

Active high

An event is carried out on the rising edge of the digital input (low to high). Response time $t(\text{on}) / t(\text{off})$ after a switch-on signal.

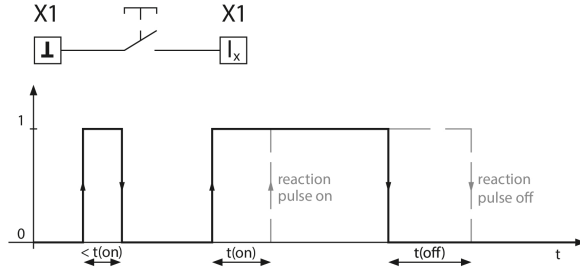

Active low

An event is carried out on the falling edge of the digital input (high to low). Response time $t(\text{on}) / t(\text{off})$ after a switch-off signal.

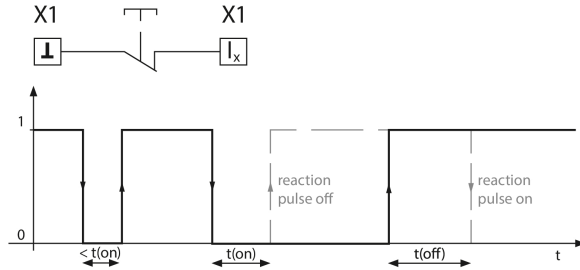

Menu item: $t(\text{on})$

The response time $t(\text{on})$ after a switch-on signal can be set from 100 ms to 300 s.

Menu item: $t(\text{off})$

The response time $t(\text{off})$ after a switch-off signal can be set from 100 ms to 300 s.

Menu item: Function

You can configure the parameters of the ISOMETER®'s digital inputs for different functions:

- off** Digital input without function
- RESET** Reset of fault and alarm messages
- Deactivate device** The device does NOT measure the insulation resistance, the message **Device inactive** appears on the display. The IT system is NOT being monitored!
The device automatically disconnects itself from the network to be monitored via internal circuit breakers.
- Start initial measurement** All recorded measured values are discarded, and a new measurement will be started.
- Insulation fault location** The insulation fault location is started.
For this purpose, the digital input must be active.
- ISOLoop** Activates the ISOLoop function.



Deactivation of the ISOMETER® with digital inputs

The digital inputs are not interconnected. In order to avoid unintentional deactivation of the ISOMETER®, it should be ensured during configuration that different functions are assigned to the inputs.

8.2.1.11 Outputs

The ISOMETER® provides a total of six outputs (including buzzer). The following parameters can be set for the outputs:

8.2.1.11.1 Relays 1 and 2

The following relay parameters can be set:

Menu item: TEST

The functional test of the relay can be activated or deactivated. This only applies to the manual test and not to the cyclic device self test:

- on** The manual test checks the switching function of the relay
- off** The manual test does not check the switching function of the relay

Menu item: Relay mode

The relay mode can be adapted to the application:

- N/C** N/C operation of the contacts 11-12-14 / 21-22-24
(in fault-free condition, the alarm relay is energised).
- N/O** N/O operation of the contacts 11-12-14 / 21-22-24
(in fault-free condition, the alarm relay is energised).
- Flash** The relay flashes. Flash rate: 1 s ON / 1 s OFF

Menu item: Functions 1 to 3

Up to 3 functions can be assigned to one output. The functions are linked to an OR operator:

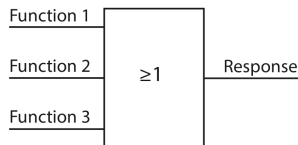

Selectable functions

Name in menu	Description
off	The function is not used.
Ins. alarm 1	The status of the output changes when the value falls below the set response value R_{an1} .
Ins. alarm 2	The status of the output changes when the value falls below the set response value R_{an2} .

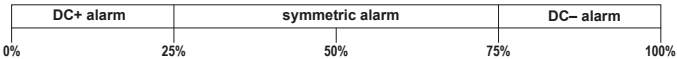
Name in menu	Description
Connection fault	The status of the output changes when one of the following connection faults occurs: <ul style="list-style-type: none"> • No low-resistance connection between the line conductors • No low-resistance connection between terminals E and KE to earth (PE) • Load at voltage output too low • The load connected to the current output is too high • Load on X1 too high
DC– alarm	The status of the output changes in case of an earth fault in the direction of DC – when 75 % of the value is exceeded. This does not concern symmetrical faults. This function will only be carried out when the value falls below the response value R_{an1} and when the nominal system voltage is $U_n \geq 50$ V.
DC+ alarm	The status of the output changes in case of an earth fault in the direction of DC+ when 25 % of the value are exceeded. This does not concern symmetrical faults. This function will only be carried out when the value falls below the response value R_{an1} and when the nominal system voltage is $U_n \geq 50$ V.
Symmetrical alarm	The status of the output changes in the event of a resistance ratio between DC+ and DC– of 25 % to 75 %.
	
Device fault	The status of the output changes in the event of an internal device fault.
Common alarm	The status of the output changes on the occurrence of any alarm or fault messages (Ins. alarms 1 & 2, DC– / DC+ alarms, symmetrical alarm, connection and device errors).
Measurement complete	The status of the output changes at the end of the initial measurement.
Device inactive	<p><i>Initial value:</i> When the device becomes inactive, the maximum measured value of the measuring range is displayed and all insulation faults are reset.</p> <p><i>Keep state:</i> When the device becomes inactive, the maximum measured value and the insulation faults that were present at the time of the device deactivation are displayed.</p>
DC offset alarm	The status of the output changes in the event of a DC shift voltage.
Common alarm EDS	Change of state on the occurrence of any alarm in one of the connected EDS devices.
EDS locating pulse	Change of state in the PGH cycle, if insulation fault location is active.
Connection error	The status of the output changes in case of one of the following errors: <ul style="list-style-type: none"> • General ISOnet error • ISOnet device timeout • ISOnet missing device • EDSsync error • ISOloop error

8.2.1.11.2 Digital outputs 1 and 2

The following parameters can be set for each of the digital outputs:

Menu item: TEST

The functional test of the digital output can be activated or deactivated. This only applies to the manual test and not to the cyclic device self test:

- on** The manual test changes the status of the digital output.
- off** The manual test does not change the status of the digital output.

Menu item: Mode

The operating mode of the digital output has the following values:

- Active** In active mode, +24 V are applied internally to output Q_x.

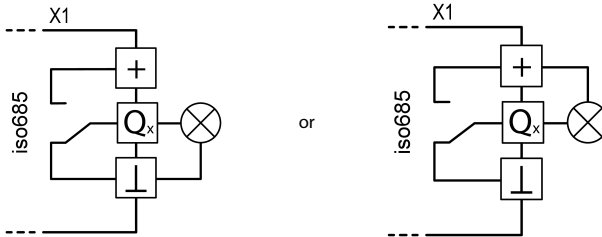

- Passive** In passive mode, ≤ 32 V are connected externally (see technical data). The output switches the applied potential to ground.

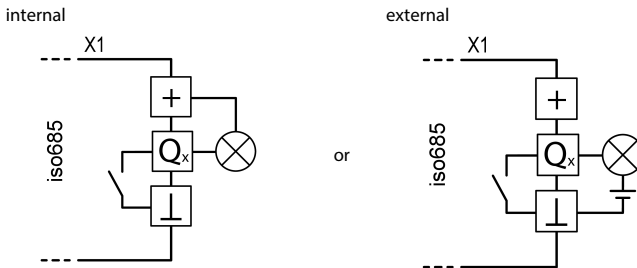

Observe the maximum output current!

Maximum output current in case of internal voltage supply via A1/+ and A2/-: 200 mA in total on X1. Also observe the formula for calculating I_{LmaxX1} in Inputs/outputs (X1) in section Tabular data iso685-x-P-B.

Menu item: Functions 1 to 3

Up to 3 functions can be assigned to one output. The functions are linked to an OR operator:

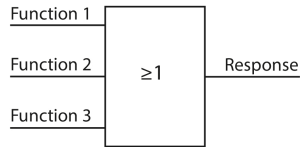

Selectable functions

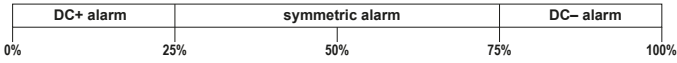
Name in menu	Description
off	The function is not used.
Ins. alarm 1	The status of the output changes when the value falls below the set response value R_{an1} .
Ins. alarm 2	The status of the output changes when the value falls below the set response value R_{an2} .
Connection fault	The status of the output changes when one of the following connection faults occurs: <ul style="list-style-type: none"> • No low-resistance connection between the line conductors • No low-resistance connection between terminals E and KE to earth (PE) • Load at voltage output too low • The load connected to the current output is too high • Load on X1 too high
DC- alarm	The status of the output changes in case of an earth fault in the direction of DC – when 75 % of the value is exceeded. This does not concern symmetrical faults. This function will only be carried out when the value falls below the response value R_{an1} and when the nominal system voltage is $U_n \geq 50$ V.
DC+ alarm	The status of the output changes in case of an earth fault in the direction of DC+ when 25 % of the value are exceeded. This does not concern symmetrical faults. This function will only be carried out when the value falls below the response value R_{an1} and when the nominal system voltage is $U_n \geq 50$ V.
Symmetrical alarm	The status of the output changes in the event of a resistance ratio between DC+ and DC– of 25 % to 75 %.
	
Device fault	The status of the output changes in the event of an internal device fault.
Common alarm	The status of the output changes on the occurrence of any alarm or fault messages (Ins. alarms 1 & 2, DC– / DC+ alarms, symmetrical alarm, connection and device errors).
Measurement complete	The status of the output changes at the end of the initial measurement.

Name in menu	Description
Device inactive	<p><i>Initial value:</i> When the device becomes inactive, the maximum measured value of the measuring range is displayed and all insulation faults are reset.</p> <p><i>Keep state:</i> When the device becomes inactive, the maximum measured value and the insulation faults that were present at the time of the device deactivation are displayed.</p>
DC offset alarm	The status of the output changes in the event of a DC shift voltage.
Common alarm EDS	Change of state on the occurrence of any alarm in one of the connected EDS devices.
EDS locating pulse	Change of state in the PGH cycle, if insulation fault location is active.
Connection error	<p>The status of the output changes in case of one of the following errors:</p> <ul style="list-style-type: none"> • General ISONet error • ISONet device timeout • ISONet missing device • EDSsync error • ISOloop error

8.2.1.11.3 Buzzer

The following parameters can be set for the buzzer.

Menu item: TEST

The functional test of the buzzer can be activated or deactivated. This only applies to the manual test and not to the cyclic device self test.

- on** The manual test activates the buzzer sound.
- off** The manual test does not activate the buzzer sound.

Menu item: Functions 1 to 3

Up to 3 functions can be assigned to one output. The functions are linked to an OR operator:

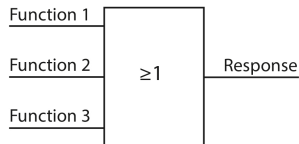

Selectable functions

Name in menu	Description
off	The function is not used.
Ins. alarm 1	The status of the output changes when the value falls below the set response value R_{an1} .

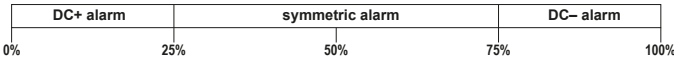
Name in menu	Description
Ins. alarm 2	The status of the output changes when the value falls below the set response value R_{an2} .
Connection fault	The status of the output changes when one of the following connection faults occurs: <ul style="list-style-type: none"> • No low-resistance connection between the line conductors • No low-resistance connection between terminals E and KE to earth (PE) • Load at voltage output too low • The load connected to the current output is too high • Load on X1 too high
DC– alarm	The status of the output changes in case of an earth fault in the direction of DC – when 75 % of the value is exceeded. This does not concern symmetrical faults. This function will only be carried out when the value falls below the response value R_{an1} and when the nominal system voltage is $U_n \geq 50$ V.
DC+ alarm	The status of the output changes in case of an earth fault in the direction of DC+ when 25 % of the value are exceeded. This does not concern symmetrical faults. This function will only be carried out when the value falls below the response value R_{an1} and when the nominal system voltage is $U_n \geq 50$ V.
Symmetrical alarm	The status of the output changes in the event of a resistance ratio between DC+ and DC– of 25 % to 75 %.
	
Device fault	The status of the output changes in the event of an internal device fault.
Common alarm	The status of the output changes on the occurrence of any alarm or fault messages (Ins. alarms 1 & 2, DC– / DC+ alarms, symmetrical alarm, connection and device errors).
Measurement complete	The status of the output changes at the end of the initial measurement.
Device inactive	<i>Initial value:</i> When the device becomes inactive, the maximum measured value of the measuring range is displayed and all insulation faults are reset. <i>Keep state:</i> When the device becomes inactive, the maximum measured value and the insulation faults that were present at the time of the device deactivation are displayed.
DC offset alarm	The status of the output changes in the event of a DC shift voltage.
Common alarm EDS	Change of state on the occurrence of any alarm in one of the connected EDS devices.
EDS locating pulse	Change of state in the PGH cycle, if insulation fault location is active.

Name in menu	Description
Connection error	<p>The status of the output changes in case of one of the following errors:</p> <ul style="list-style-type: none"> • General ISONet error • ISONet device timeout • ISONet missing device • EDSsync error • ISLoop error

8.2.1.11.4 Analogue output

The analogue output can be configured using the following parameters:

Menu item: Mode

The operating mode of the analogue output has the following values:

Current output

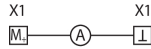

- **0-20 mA** Permissible load $\leq 600 \Omega$
- **4-20 mA** Permissible load $\leq 600 \Omega$
- **0-400 μ A** Permissible load $\leq 4 \text{ k}\Omega$

Voltage output

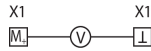

- **0-10 V** Permissible load $\geq 1 \text{ k}\Omega$
- **2-10 V** Permissible load $\geq 1 \text{ k}\Omega$

Menu item: Midscale

Select the appropriate midscale. The following parameters can be set:

Linear

The switching signal is linear to the insulation resistance in the indicated measuring range.

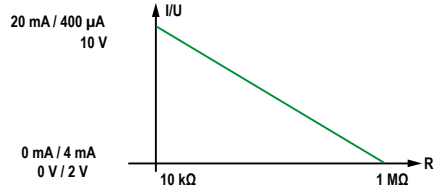

28 kΩ
120 kΩ

The switching signal is analogue to the midscale of 28 kΩ or 120 kΩ on a measuring instrument.

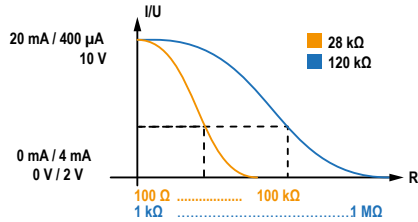
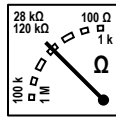

Calculation of the insulation resistance using the analogue output:

$$R_F = \frac{(A_2 - A_1) * R_{SKM}}{A_3 - A_1} - R_{SKM}$$

A_3 = Measured value analogue output

R_{SKM} = 28 kΩ or 120 kΩ/midscale

R_F = Insulation fault in kΩ

Lower value, output A ₁	Upper value, output A ₂
0 mA	20 mA
4 mA	20 mA
0 µA	400 µA
0 V	10 V
2 V	10 V

Menu item: TEST

The functional test of the analogue output can be activated or deactivated. In this way, the analogue output is adjusted once for the entire range. This only applies to the manual test and not to the cyclic device self test:

- on** The manual test checks the analogue output function.
- off** The manual test does not check the analogue output function.

Menu item: Function

Select the appropriate setting for the analogue output. The following parameters can be set.

Insulation value

Depending on the measured insulation value, an analogue current or voltage signal is provided at the output.

DC offset

Depending on the measured DC offset, an analogue current or voltage signal is provided at the output. This setting can only be used when **Linear** is selected in the menu **Midscale**.

DC+ alarm		symmetric alarm		DC- alarm	
0%		25%		75%	100%
	0 V / 2 V				10 V
	0 mA / 4 mA				20 mA
	0 µA				400 µA

8.2.2 EDS (insulation fault location)

8.2.2.1 General

8.2.2.1.1 Current



CAUTION *Locating currents at sensitive parts of the installation too high!*

The locating current flowing between the IT system and earth can cause control faults in sensitive parts of the installation, such as the PLC or relays.

Ensure that the level of the locating current is compatible with the system to be monitored.

Set the maximum locating current on the ISOMETER®. The device-specific maximum locating currents can be found in the table below.

1 mA	for EDS441-x
1.8 mA	for EDS441-x
2.5 mA	for EDS441-x
5 mA	for EDS441-x, EDS440-x
10 mA	for EDS440-x
25 mA	for EDS440-x
50 mA	for EDS440-x

8.2.2.1.2 Mode

To locate insulation faults, select one of the three available modes for insulation fault location.

manual	In manual mode, the insulation fault location does not start automatically. If you start the insulation fault location, it remains active without considering the insulation resistance and the alarm message of the ISOMETER®.
auto	In auto mode, the insulation fault location starts automatically as soon as the response value of Alarm 2 of the ISOMETER® has fallen below the preset value. The insulation fault location is cyclically interrupted for an insulation measurement. If the insulation fault still exists after the interruption, the insulation fault location starts again. The insulation fault location only stops when Alarm 2 becomes inactive. If a new insulation fault appears, the insulation fault location restarts automatically.
1 cycle	In 1-cycle mode, the insulation fault location starts automatically as soon as the response value of alarm 2 of the ISOMETER® has fallen below the preset value. The insulation fault location is stopped after one cycle. If the insulation fault still exists after the interruption, the insulation fault location does NOT start again. If a new insulation fault appears, the insulation fault location restarts automatically for one cycle.

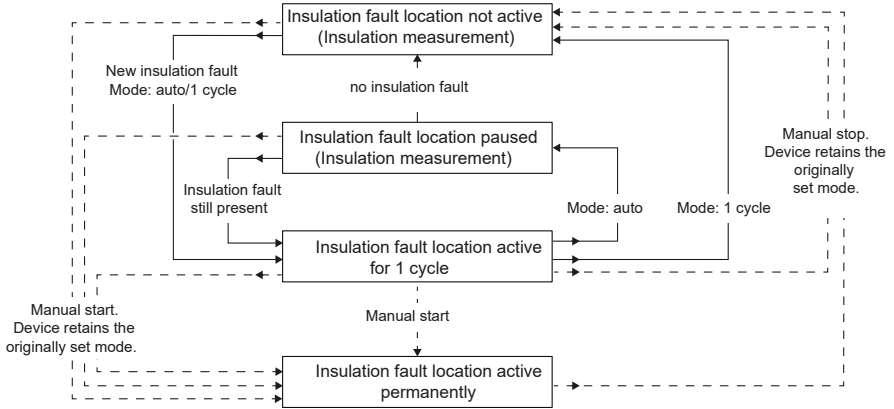

i Do not carry out a manual test during a manually started insulation fault location, since the insulation fault location would be aborted by that.

8.2.2.1.3 Using a portable EDS

If you would like to use a portable EDS, activate this function here. After that, the insulation fault location process will be automatically adjusted.

- on** Insulation faults can be located with a portable EDS.
- off** Insulation faults cannot be located with a portable EDS.

i If the trigger mode is set to **auto**, the use of a portable EDS must be activated in the menu as the measurement method is adjusted correspondingly at this menu item.

8.2.2.1.4 EDSsync

In coupled systems, the EDSsync function ensures that all ISOMETER®s with the EDS devices that are connected to them and which are grouped by means of the Group Manager in one group participate in the insulation fault location (see chapter “Special functions for coupled IT systems”, page 96).

- on** Activates the coupled insulation fault location.
- off** Deactivates the coupled insulation fault location.

8.2.2.1.5 Scan for channels

This function defines how the process **Scanning for channels** is started. During a channel scan the BS and BB buses are searched for present (detected) EDS devices. Internally these are assigned in consecutive order to Modbus registers.

i **Assignment of Modbus registers to initialised addresses**
 An already initialised Modbus table may be changed, when gaps in the addresses (physical address of the EDS) occur or devices are inserted into existing (initialised) address gaps. Before performing a manual channel scan, consult with the programmer of the Modbus interface.

auto With this option a channel scan is carried out with every restart of the ISOMETER®. The process **Scan for channels** is also started automatically when the iso685 detects that

- EDS devices were added
- EDS devices were removed or switched off
- the addresses of one or more EDS devices have been changed.

If a bus node is no longer present or is added, the ISOMETER® asks whether a channel scan (see “Scan for channels”, page 62) shall be carried out and then detects all channels after 30 s. Within these 30 s the channel scan can be aborted to avoid an offset of the Modbus register assignments.

See also chapter 12, Alarm messages.

manual With this option no channel scan is started with a restart of the ISOMETER®. During operation, the process **Scan for channels** can be started manually by the user. When a channel scan is carried out manually, the Modbus registers are reassigned.

8.2.2.2 Scan for channels

For a successful insulation fault location, all active measuring channels must be determined. Indicate if you would like to start the search for EDS measuring channels.

Cancel Aborts the scan process.

Start Starts the scan process (search) for EDS channels.

8.2.2.3 Enable channels

During initial commissioning all channels are disabled. Before configuring the channels, they must be enabled in this menu. Select which measuring channels you would like to enable.

Multiple selection is possible.

Select all	All channels are selected.
No selection	No channel is selected.
Invert selection	The current selection is inverted.
<input checked="" type="checkbox"/> Channel 1 (BS 2/1)	Channel is selected.
...	
<input type="checkbox"/> Channel 12 (BS 2/12)	Channel is not selected.

Navigate to the required menu item using \wedge and \vee .

Confirm selection by pressing **OK**.

Enable the selected channels are with $>$.

8.2.2.4 Group settings

Use group settings to adjust the settings for several EDS devices or EDS channels simultaneously or to read out settings.

If you would like to make settings for each EDS or each EDS channel individually, then please refer to the menus from “Channel [configuration]”, page 70 to “Device”, page 76.



Display of values in the group settings

Every time the group configuration is opened, the display of all settings shows --, regardless of the actual values currently set. Parameter values are only displayed immediately after a parameter has been set and the respective menu has not been left. To see the values of the individual EDS, please navigate to the menus "Channel [configuration]", page 70 to "Device", page 76.

8.2.2.4.1 Channel

Before configuring a measuring channel, you must activate it.

Select which measuring channels you would like to activate and configure.

Select all	All channels are selected.
No selection	No channel is selected.
Invert selection	The current selection is inverted.
<input checked="" type="checkbox"/> Channel 1 (BS 2/1)	Channel is selected.
...	
<input type="checkbox"/> Channel 12 (BS 2/12)	Channel is not selected.

Navigate to the required menu item using \wedge and \vee .

Use \gt to activate the selected measuring channels and to navigate to their setting options.

Menu item: Current transformers (CT)

Set the current transformer used.

TYPE A	W... / WR... / WS...
TYPE A	W...AB

Menu item: CT monitoring

Enable or disable the CT monitoring.

If CT monitoring is enabled, an alarm is signalled as soon as a fault occurs on a current transformer of an activated channel (short circuit or interruption).

on	CT monitoring is enabled.
off	CT monitoring is disabled.

Menu item: $I_{\Delta L}$ response value

Set the response value for $I_{\Delta L}$ (main alarm for insulation fault location) between 200 μ A and 10 mA. The response value must be below the set locating current.



CAUTION

The permissible response value and the response sensitivity depend on the connected EDS (EDS440x or EDS441x).

Menu item: $I_{\Delta n}$ response value

Set the response value for $I_{\Delta n}$ (alarm for residual current measurement) between 100 mA and 10 A.



CAUTION

The permissible response value and the response sensitivity depend on the connected EDS (EDS440x or EDS441x).

8.2.2.4.2 Outputs

Make settings for the outputs of the EDS and the IOM441-S.

Common relays

Channel relays

Buzzer

Dig. output

Menu item: Common relays

Select the relays that you want to set.

Select all	All channels are selected.
No selection	No channel is selected.
Invert selection	The current selection is inverted.
<input checked="" type="checkbox"/> Relay 1 (BS 2/1)	Relay is selected.
<input type="checkbox"/> Relay 2 (BS 2/2)	Relay is not selected.

TEST

Activating or deactivating the manual function test of the relay.

on	The manual test checks the switching function of the relay.
off	The manual test does not check the switching function of the relays.

Relay mode

The relay operating mode can be adapted to the application.

N/C	Normally closed - N/C operation, contacts 11-12-14 / 21-22-24 In fault-free condition, the alarm relay is energised.
N/O	Normally opened - N/O operation, contacts 11-12-14 / 21-22-24 In fault-free condition, the alarm relay is de-energised.

Functions 1 to 3

Up to three functions can be assigned to one output. The functions are linked via an OR operator:

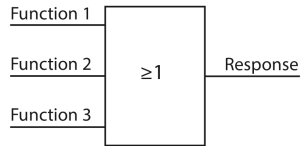

Selectable functions

off	The function is not used.
$I_{\Delta L}$	Output status changes if an insulation fault is detected on one of the measuring channels. (EDS function)
$I_{\Delta n}$	Output status changes if the residual current is exceeded. (RCM function)
Device error	Output status changes in the event of an internal device error.
Connection fault	Output status changes when one of the following measuring current transformer connection faults occurs: <ul style="list-style-type: none"> • Measuring current transformers defective • Power supply cable interrupted • Power supply cable short-circuited
Common alarm	The status of the output changes on the occurrence of any alarms and fault messages ($I_{\Delta L}$ alarm, $I_{\Delta n}$ alarm, connection and device error).

Menu item: Channel relays

Select the relays that you want to set.

Select all	All channels are selected.
No selection	No channel is selected.
Invert selection	The current selection is inverted.
<input checked="" type="checkbox"/> Relay 1 (BS 2/1)	Relay is selected.
<input type="checkbox"/> Relay 2 (BS 2/2)	Relay is not selected.

TEST

Activating or deactivating the manual function test of the relay.

on	The manual test checks the switching function of the relay.
off	The manual test does not check the switching function of the relays.

Relay mode

The relay operating mode can be adapted to the application.

N/C	Normally closed - N/C operation, contacts 11-12-14 / 21-22-24 In fault-free condition, the alarm relay is energised.
N/O	Normally opened - N/O operation, contacts 11-12-14 / 21-22-24 In fault-free condition, the alarm relay is de-energised.

Functions 1 to 3

Up to three functions can be assigned to one output. The functions are linked via an OR operator:

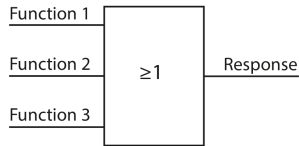

Selectable functions

off	The function is not used.
$I_{\Delta L}$	Output status changes if an insulation fault is detected on one of the measuring channels. (EDS function)
$I_{\Delta n}$	Output status changes if the residual current is exceeded. (RCM function)
Connection fault	Output status changes when one of the following measuring current transformer connection faults occurs: <ul style="list-style-type: none"> • Measuring current transformers defective • Power supply cable interrupted • Power supply cable short-circuited

Menu item: Buzzer

Select the buzzers that you would like to configure.

Select all	All buzzers are selected.
No selection	No buzzer is selected.
Invert selection	The current selection is inverted.
<input checked="" type="checkbox"/> Buzzer 1 (BS 2/1)	A single buzzer is selected.

Afterwards, assign the selected buzzers to the events on which they should trip.

Menu item: TEST

The functional test of the buzzer can be activated or deactivated. This only applies to the manual test and not to the cyclic device self test.

on	The manual test activates the buzzer sound
off	The manual test does not activate the buzzer sound

Menu item: Functions 1 to 3

Up to three functions can be assigned to one output. The functions are linked via an OR operator:

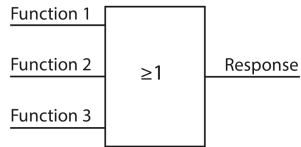

Selectable functions

off	The function is not used.
I_{ΔL}	Output status changes if an insulation fault is detected on one of the measuring channels. (EDS function)
I_{Δn}	Output status changes if the residual current is exceeded. (RCM function)
Device error	Output status changes in the event of an internal device error.
Connection fault	Output status changes when one of the following measuring current transformer connection faults occurs: <ul style="list-style-type: none"> • Measuring current transformers defective • Power supply cable interrupted • Power supply cable short-circuited
Common alarm	The status of the output changes on the occurrence of any alarms and fault messages (I _{ΔL} alarm, I _{Δn} alarm, connection and device error).
Insulation fault location active	The buzzer signals active insulation fault location.

Digital output

Select the digital outputs of the EDS that you would like to configure.

Select all	All digital outputs are selected.
No selection	No digital output is selected
Invert selection	The current selection is inverted.
<input checked="" type="checkbox"/> Dig. output 1 (BS 2/1)	A single digital output is selected.

Afterwards, make the settings for the selected digital inputs of the EDS.

TEST

Activating and deactivating manual tests:

on	The manual test changes the status of the digital output.
off	The manual test does not change the status of the digital output.

Functions 1 to 3

Up to three functions can be assigned to one output. The functions are linked via an OR operator:

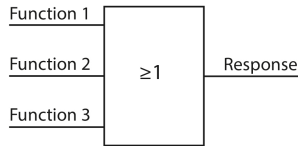

Selectable functions

off	The function is not used.
$I_{\Delta L}$	Output status changes if an insulation fault is detected on one of the measuring channels. (EDS function)
$I_{\Delta n}$	Output status changes if the residual current is exceeded. (RCM function)
Device error	Output status changes in the event of an internal device error.
Connection fault	Output status changes when one of the following measuring current transformer connection faults occurs: <ul style="list-style-type: none"> • Measuring current transformers defective • Power supply cable interrupted • Power supply cable short-circuited
Common alarm	The status of the output changes on the occurrence of any alarms and fault messages ($I_{\Delta L}$ alarm, $I_{\Delta n}$ alarm, connection and device error).
BS bus malfunction	Message in case of a faulty BS bus connection <ul style="list-style-type: none"> • No master available • A/B interchanged • A/B short-circuited • A/B separated

8.2.2.4.3 Dig. input

Select the digital inputs of the EDS that you would like to configure:

Select all	All digital inputs are selected.
No selection	No digital input is selected.
Invert selection	The current selection is inverted.
<input checked="" type="checkbox"/> Dig. input 1 (BS 2/1)	Digital input is selected.
<input type="checkbox"/> Dig. input 2 (BS 2/2)	Digital input is not selected.

Afterwards, make the settings for the selected digital inputs of the EDS.

Menu item: Mode

The operating mode for the digital input can be set to the following values. For a description, refer to "Digital inputs 1 to 3", page 50. The following can be selected:

- Active high** An event is carried out on the rising edge of the digital input (low to high).
Active low An event is carried out on the falling edge of the digital input (high to low).

Menu item: Response time t_{on}

The response time t_{on} after a switch-on signal can be set between 100 milliseconds and 300 seconds.

Menu item: Response time t_{off}

The response time t_{off} after a switch-off signal can be set between 100 milliseconds and 300 seconds.

Menu item: Function

- off** Digital input without function
TEST Device self test
RESET Reset of fault and alarm messages

8.2.2.4.4 Device settings

- Select all** All devices are selected.
No selection No device is selected.
Invert selection The current selection is inverted.

BS bus 2 (1-12)

Menu item: System type

Settings made to this menu item will only have an effect on connected EDS460 and NOT on EDS44x devices.

- DC** Direct current system
AC Single-phase AC system
3AC Three-phase AC system

Menu item: Frequency

Configure the mains frequency of the IT system to be monitored.

- 50 Hz**
60 Hz
400 Hz
DC

Menu item: Trigger

The locating current pulse of the ISOMETER® is synchronised with the measurement technology in the EDS via the BB bus or the BS bus. This allows a more reliable detection of the locating current pulse in the event of disturbances. Disturbances can be caused e.g. by variable-speed drives, rectifiers, actuators, noise filters, PLCs, or control electronics.

Com Synchronisation via BS bus or BB bus. The EDS only searches for insulation faults if the insulation fault location has been started. Less time is needed for the insulation fault location than with the **auto** setting.

auto No synchronisation (e.g. if there is no BS bus or BB bus). The EDS continuously searches for insulation faults.



*If the trigger mode is set to **auto**, the use of a portable EDS must be activated in the menu ("Using a portable EDS", page 61 = **on**), since the measurement method is adjusted correspondingly at this menu item.*

Menu item: Fault memory

Faults that only occur temporarily can be stored.

on After eliminating the cause of fault, alarm messages remain stored until a reset is carried out. This function applies to alarm and device error messages.

off The EDS exits the alarm mode as soon as the cause of a fault is eliminated.

8.2.2.5 Channel [configuration]

In this menu, each channel can be configured.

Use \wedge and \vee to select a channel.

Use $>$ to enter the submenu with the parameters shown below.

Use $<$ or **ESC** to return to the higher menu level.

Menu item: Name

Enter a name for the selected channel. This name will also be displayed on the gateways and in the web server and can be edited via these as well.

Menu item: CT monitoring

Enable or disable the CT monitoring.

If CT monitoring is enabled, an alarm is signalled as soon as a fault occurs on a current transformer of an activated channel (short circuit or interruption).

on CT monitoring is enabled.

off CT monitoring is disabled.

Menu item: $I_{\Delta L}$ response value

Set the response value for $I_{\Delta L}$ (main alarm for insulation fault location) between 200 μ A and 10 mA. The response value must be below the set locating current.



CAUTION

The permissible response value and the response sensitivity depend on the connected EDS (EDS440x or EDS441x).

Menu item: $I_{\Delta n}$ response value

Set the response value for $I_{\Delta n}$ (alarm for residual current measurement) between 100 mA and 10 A.



CAUTION

The permissible response value and the response sensitivity depend on the connected EDS (EDS440x or EDS441x).

8.2.2.6 Outputs

In this menu, each output can be configured. Also refer to "Outputs", page 64.

Menu item: Common relays

Select the relays that you want to set.

- | | |
|---|------------------------------------|
| Select all | All channels are selected. |
| No selection | No channel is selected. |
| Invert selection | The current selection is inverted. |
| <input checked="" type="checkbox"/> Relay 1 (BS 2/1) | Relay is selected. |
| <input type="checkbox"/> Relay 2 (BS 2/2) | Relay is not selected. |

TEST

Activating or deactivating the manual function test of the relay.

- | | |
|------------|--|
| on | The manual test checks the switching function of the relay. |
| off | The manual test does not check the switching function of the relays. |

Relay mode

The relay operating mode can be adapted to the application.

- | | |
|------------|--|
| N/C | Normally closed - N/C operation, contacts 11-12-14 / 21-22-24
In fault-free condition, the alarm relay is energised. |
| N/O | Normally opened - N/O operation, contacts 11-12-14 / 21-22-24
In fault-free condition, the alarm relay is de-energised. |

Functions 1 to 3

Up to three functions can be assigned to one output. The functions are linked via an OR operator:

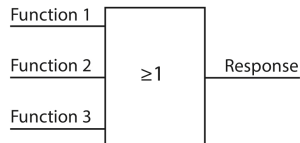

Selectable functions

- | | |
|----------------|---|
| off | The function is not used. |
| $I_{\Delta L}$ | Output status changes if an insulation fault is detected on one of the measuring channels. (EDS function) |

$I_{\Delta n}$	Output status changes if the residual current is exceeded. (RCM function)
Device error	Output status changes in the event of an internal device error.
Connection fault	Output status changes when one of the following measuring current transformer connection faults occurs: <ul style="list-style-type: none"> • Measuring current transformers defective • Power supply cable interrupted • Power supply cable short-circuited
Common alarm	The status of the output changes on the occurrence of any alarms and fault messages ($I_{\Delta L}$ alarm, $I_{\Delta n}$ alarm, connection and device error).

Menu item: Channel relays

Select the relays that you want to set.

Select all	All channels are selected.
No selection	No channel is selected.
Invert selection	The current selection is inverted.
<input checked="" type="checkbox"/> Relay 1 (BS 2/1)	Relay is selected.
<input type="checkbox"/> Relay 2 (BS 2/2)	Relay is not selected.

TEST

Activating or deactivating the manual function test of the relay.

on	The manual test checks the switching function of the relay.
off	The manual test does not check the switching function of the relays.

Relay mode

The relay operating mode can be adapted to the application.

N/C	Normally closed - N/C operation, contacts 11-12-14 / 21-22-24 In fault-free condition, the alarm relay is energised.
N/O	Normally opened - N/O operation, contacts 11-12-14 / 21-22-24 In fault-free condition, the alarm relay is de-energised.

Functions 1 to 3

Up to three functions can be assigned to one output. The functions are linked via an OR operator:

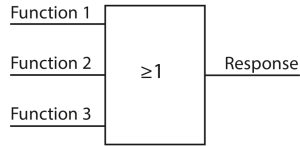

Selectable functions

off	The function is not used.
$I_{\Delta L}$	Output status changes if an insulation fault is detected on one of the measuring channels. (EDS function)
$I_{\Delta n}$	Output status changes if the residual current is exceeded. (RCM function)
Connection fault	Output status changes when one of the following measuring current transformer connection faults occurs: <ul style="list-style-type: none"> • Measuring current transformers defective • Power supply cable interrupted • Power supply cable short-circuited

Menu item: Buzzer

Select the buzzers that you would like to configure.

Select all	All buzzers are selected.
No selection	No buzzer is selected.
Invert selection	The current selection is inverted.
<input checked="" type="checkbox"/> Buzzer 1 (BS 2/1)	A single buzzer is selected.

Afterwards, assign the selected buzzers to the events on which they should trip.

Menu item: TEST

The functional test of the buzzer can be activated or deactivated. This only applies to the manual test and not to the cyclic device self test.

on	The manual test activates the buzzer sound
off	The manual test does not activate the buzzer sound

Menu item: Functions 1 to 3

Up to three functions can be assigned to one output. The functions are linked via an OR operator:

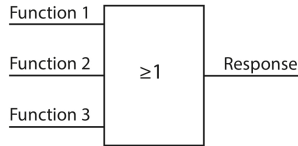

Selectable functions

off	The function is not used.
$I_{\Delta L}$	Output status changes if an insulation fault is detected on one of the measuring channels. (EDS function)
$I_{\Delta n}$	Output status changes if the residual current is exceeded. (RCM function)
Device error	Output status changes in the event of an internal device error.
Connection fault	Output status changes when one of the following measuring current transformer connection faults occurs: <ul style="list-style-type: none"> • Measuring current transformers defective • Power supply cable interrupted • Power supply cable short-circuited
Common alarm	The status of the output changes on the occurrence of any alarms and fault messages ($I_{\Delta L}$ alarm, $I_{\Delta n}$ alarm, connection and device error).
Insulation fault location active	The buzzer signals active insulation fault location.

Digital output

Select the digital outputs of the EDS that you would like to configure.

Select all	All digital outputs are selected.
No selection	No digital output is selected
Invert selection	The current selection is inverted.
<input checked="" type="checkbox"/> Dig. output 1 (BS 2/1)	A single digital output is selected.

Afterwards, make the settings for the selected digital inputs of the EDS.

TEST

Activating and deactivating manual tests:

on	The manual test changes the status of the digital output.
off	The manual test does not change the status of the digital output.

Functions 1 to 3

Up to three functions can be assigned to one output. The functions are linked via an OR operator:

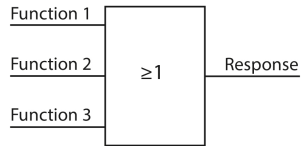

Selectable functions

off	The function is not used.
$I_{\Delta L}$	Output status changes if an insulation fault is detected on one of the measuring channels. (EDS function)
$I_{\Delta n}$	Output status changes if the residual current is exceeded. (RCM function)
Device error	Output status changes in the event of an internal device error.
Connection fault	Output status changes when one of the following measuring current transformer connection faults occurs: <ul style="list-style-type: none"> • Measuring current transformers defective • Power supply cable interrupted • Power supply cable short-circuited
Common alarm	The status of the output changes on the occurrence of any alarms and fault messages ($I_{\Delta L}$ alarm, $I_{\Delta n}$ alarm, connection and device error).
BS bus malfunction	Message in case of a faulty BS bus connection <ul style="list-style-type: none"> • No master available • A/B interchanged • A/B short-circuited • A/B separated

8.2.2.7 Inputs

In this menu every digital input can be configured. Select an input.

Dig. input 1 (BS 2/1)

Dig. input 2 (BS 2/2)

Menu item: Mode

The operating mode for the digital input can be set to the following values. For a description, refer to “Digital inputs 1 to 3”, page 50. The following can be selected:

Active high	An event is carried out on the rising edge of the digital input (low to high).
Active low	An event is carried out on the falling edge of the digital input (high to low).

Menu item: Response time t_{on}

The response time t_{on} after a switch-on signal can be set between 100 milliseconds and 300 seconds.

Menu item: Response time t_{off}

The response time t_{off} after a switch-off signal can be set between 100 milliseconds and 300 seconds.

Menu item: Function

off	Digital input without function
TEST	Device self test
RESET	Reset of fault and alarm messages

8.2.2.8 Device

Menu item: Trigger

The locating current pulse of the ISOMETER® is synchronised with the measurement technology in the EDS via the BB bus or the BS bus. This allows a more reliable detection of the locating current pulse in the event of disturbances. Disturbances can be caused e.g. by variable-speed drives, rectifiers, actuators, noise filters, PLCs, or control electronics.

Com	Synchronisation via BS bus or BB bus. The EDS only searches for insulation faults if the insulation fault location has been started. Less time is needed for the insulation fault location than with the auto setting.
auto	No synchronisation (e.g. if there is no BS bus or BB bus). The EDS continuously searches for insulation faults.



*If the trigger mode is set to **auto**, the use of a portable EDS must be activated in the menu ("Using a portable EDS", page 61 = **on**), since the measurement method is adjusted correspondingly at this menu item.*

Menu item: Fault memory

Faults that only occur temporarily can be stored.

on	After eliminating the cause of fault, alarm messages remain stored until a reset is carried out. This function applies to alarm and device error messages.
off	The EDS exits the alarm mode as soon as the cause of a fault is eliminated.

8.2.2.9 Factory setting

In this menu, the EDS devices can be reset to the factory settings.

Select all	All EDS devices are selected.
No selection	No EDS device is selected.
Invert selection	The current selection is inverted.
<input checked="" type="checkbox"/> BS bus 1 (1-12)	EDS device is selected.
...	
<input type="checkbox"/> BS bus 50 (589-600)	EDS device is not selected.

Navigate to the required menu item using \wedge and \vee .

Confirm selection by pressing **OK**.

Reset the selected EDS devices to factory setting with $>$.

8.2.2.10 Service

The service menu can only be accessed by Bender Service staff with a service password.

8.2.3 Data meas. values

The ISOMETER® stores certain measured values for a specific period of time. You can view these data in the **Data meas. value** menu. Navigate through the different views using the \wedge and \vee buttons:

Data - isoGraph	Displays the insulation resistance in chronological sequence Scaling: 1. hour 2. day 3. week 4. month 5. year
Data - Insulation	Displays the current insulation resistance, the minimum insulation resistance measured and the system leakage capacitance.
Data - IT system	Displays the system phase-to-phase voltages and the mains frequency (r.m.s. values)
Data - IT system	Displays the system phase-to-earth voltages
Data - EDS	Displays the 8 channels with the 8 highest 1. residual currents $I_{\Delta n}$ as a percentage of the respective response value 2. residual currents $I_{\Delta n}$ in A 3. locating currents $I_{\Delta l}$ in A
Data - EDS	Displays the sum total of the locating current flowing in the system $I_{\Delta l}$.

8.2.4 Control

Controlling the device during operation:

TEST	Start device test.
Reset	Reset alarm and error messages.
Start initial measurement	Discard measured values and start a new measurement.
EDS	Start insulation fault location on the connected EDS device.
Device	Set the ISOMETER® insulation resistance measurement function to active or inactive: <ul style="list-style-type: none"> • Active: The device is active. • Inactive: The device does NOT measure the insulation resistance, the message Device inactive appears on the display. The IT system is not monitored!
ISONet priority	Assign priority to a device in ISONet mode for a period of 12 hours. While the priority is active, all other devices in ISONet mode are inactive. Priority can be withdrawn at any time. After 12 hours, normal ISONet operation is set automatically.

8.2.5 History

In the history menu, the faults detected by the ISOMETER® are displayed. For a detailed description refer to "History memory", page 41.

History	Overview of faults that have occurred
Delete	Resets the history memory

8.2.6 Device settings

Here you can make the basic settings of the ISOMETER®.

8.2.6.1 Language

Selecting the display language of the device. The following languages are offered:

Deutsch
English (GB)
Español
Français
Norsk
Polski
Portugués

8.2.6.2 Clock (& Date)

Setting the time and date in the device.

Time

Setting the current time

Time format

Setting the time format

12 h 12-hour notation am/pm
24 h 24-hour notation

Summer time

Setting the mode for the change between summer and winter time

off No automatic change between summer time and standard time
DST Daylight Saving Time
Automatic time change according to North American Regulation:
Start: Second Sunday in March from 2:00 a.m. local time to 3:00 a.m. local time.
End: First Sunday in November from 3:00 a.m. local time to 2:00 a.m. (local time)
CEST Central European Summer Time
Automatic time change according to Central European Regulation:
Start: Last Sunday in March from 02:00 a.m. CET to 03:00 a.m. CEST.
End: Last Sunday in October from 03:00 a.m. CEST to 02:00 a.m. CET.

Date

Setting the current date.

Date format

Format of the displayed date

dd.mm.yy day, month, year
mm-dd-yy month, day, year

NTP

Time synchronisation via NTP server

NTP server

Entering the IP-address of the NTP server

UTC

Setting the time per UTC (coordinated universal time)

Winter time, Germany = (UTC) +1; Summer time, Germany = (UTC) +2

8.2.6.3 Interfaces

Menu for the connection of further devices to the ISOMETER® and their configuration

Write access

Configure whether the parameters of the device can be set externally via Modbus or the web server.

Displaying and reading out data via Modbus and web server is always possible, regardless of this setting.

Allow Allow external parameter setting

Deny Deny external parameter setting

Ethernet

Set the parameters for communication with other devices via the Ethernet interface. Communication with Modbus, web server and BCOM is possible.

DHCP Activates and deactivates the automatic address setting via DHCP server.
on: IP address, subnet mask and standard gateway are assigned automatically.
off: Automatic IP address assignment is deactivated. Addresses are set manually. (See the following items)

The current IP address of the device is shown in the menu **Info**.

IP *Manual entry*¹⁾ of IP address

SN *Manual entry*¹⁾ of sub net mask. Standard subnet mask: 255.255.255.0

Std.GW *Manual entry*¹⁾ of standard gateway (router) address

If there is no standard gateway in the local network, enter an address not yet used in the local address range as gateway address. The device cannot be accessed via Ethernet without a standard gateway address.

DNS *Manual entry*¹⁾ of the DNS server address

Domain *Manual entry*¹⁾ of the domain name

1) The manual entries must be made in the respective address range of the local network. Information on the current configuration of the local network is available from the administrator responsible for this network.

BCOM

Settings for communication with other devices via BCOM.

System name Entering the system name for the network in which the devices are located. All devices that communicate in one BCOM network must have the same system name.

Subsystem Entering the BCOM subsystem address. The devices can communicate with devices in subsystems with the same or a different subsystem address.

Device address Entering the device address. Within one BCOM network every device must have a different address so that it can be distinguished from other devices in the system and communicate correctly.

Timeout Setting a timeout for messages between 100 ms ... 10 s. This time specification defines the maximum permissible time for a device to respond.

TTL subscription This time of 1 s ... 1092&min defines the intervals at which the ISOMETER® sends messages to e.g. a gateway. Severe alarms (e.g. insulation alarms or substantial value changes) are always sent immediately.

Modbus TCP

Activation and deactivation for the communication with other devices via Modbus TCP.

Port 502

on Modbus TCP can be used for communication with other devices
off Modbus TCP cannot be used for communication with other devices

RS-485

Set the parameters for communication with other devices via the Bender sensor bus.

Mode Selecting the RS-485 protocol
BS bus Setting the BS bus address in the range: 1...90
isoData Settings for isoData modes: 1, 2 or 3
Modbus RTU Settings for the Modbus RTU protocol
 Address: entering an address from 1...247
 Baud rate: 9.6 | 19.2 | 37.4 | 57.6 | 115 kBd
 Parity: even | odd | none
 Stop bits: 1 | 2 | auto

8.2.6.4 Display

You can adjust the display brightness for the ISOMETER® in the **Display** menu:

Brightness

Adjust the display brightness between 0 % and 100 % in steps of 10.

If no button is pressed on the display for 15 minutes, the brightness of the display is reduced. Then, when a button is pressed, the original brightness is restored.

Automatic dimming

on Background lighting, **POWER** LED and button lighting are switched off after 3 min without operation and are only switched on again when any button is pressed. The alarm LEDs light in the event of an alarm.
off Background lighting, **POWER** LED and button lighting are switched on permanently.

8.2.6.5 Password

The password function permits protecting device parameters against unauthorised changes.

Menu item: Password

Entering the four-digit device password. The default password is 0000.

Menu item: Status

Decide whether the password query should be used:

on	Password query active
off	Password query inactive

8.2.6.6 Commissioning

In the menu **Commissioning** you can reopen the ISOMETER®'s commissioning wizard. Pressing the commissioning button immediately starts the commissioning wizard.

After going through all the queried values, the new values are accepted by the device. Press **ESC** to abort the process.

8.2.6.7 Backup

In the **Backup** menu, device settings can be saved or device settings already saved can be restored.

Save	The ISOMETER® saves your device settings.
Restore	The ISOMETER® restores your initial or your saved device settings.

8.2.6.8 Approve

Activation of special customer profiles by Bender.

The device is first configured by the Bender service and the configuration is saved in a service profile.

Activating this profile causes a warning message. The customer can activate it as a customer-specific profile by entering a *Service Profile PIN*. The warning message is then eliminated.

Profile	Enter a 4-digit Service Profile PIN
----------------	-------------------------------------

8.2.6.9 Factory settings

Resetting the device to factory settings.

8.2.6.10 Software

Functions for updating the device software. The current software version is displayed in the **Info** menu.

Update via interface	Activates the SW update via web interface.
Update	Starts update on the device. Alternatively, the update can also be started via the web interface.

Menu item: Update via interface

This function must be active if a software update is to be transferred from the web interface to the device via a BUF file.

Menu item: Update

Starts the update process after the BUF file has been transferred to the device. Alternatively, the update can also be started via the web interface.

8.2.6.11 Service

The service menu is accessible only by Bender Service.

Password	Entering the four-digit service password
-----------------	--

8.2.7 Info

The ISOMETER®s present settings can be viewed in the "Info" menu. Navigate through the different views using the \wedge and \vee buttons:

Device	Device name, serial number, article number
Software	Software version of measuring instruments, software version of HMI
Measurement	Selected profile, selected system type
EDS	PGH, current, mode
Clock	Time, date, summer time
Ethernet	IP address, DHCP status, MAC address
RS485	BS bus address, Modbus RTU address, BS bus mode

9 Device communication

9.1 Ethernet interface

The Ethernet interface can be used for the communication with BCOM, Modbus TCP, and web server.

i *A maximum of 5 TCP/IP connections can be used simultaneously.*

9.2 BCOM

BCOM is intended for communication between Bender devices via Ethernet.

In order to guarantee that all devices are able to communicate via BCOM, all devices must have the same system name. Devices can be organised in subsystems. Each device requires an individual device address.

For more information regarding BCOM, refer to the BCOM manual (D00256) at <https://www.bender.de/en/service-support/download-area/>.

i *When address 0 has been set for communication via BCOM, the device can be accessed via the network (e.g. for parameter setting, etc.) but it cannot communicate with other devices.*

9.3 Modbus TCP

Modbus is an internationally widely used protocol for data transfer between devices. Modbus TCP (Transmission Control Protocol) is implemented on the connection-oriented and packet-switched TCP protocol. This allows Modbus instructions to be transmitted via any Internet-capable connection.

Measured values, messages and parameters are stored in virtual register addresses. Data can be read out with a read command written to a register address. With a write command, data can be written into a register address. The register addresses of the individual measured values und parameters can be found in the manual "iso685-D Annex A" with the title "ISOMETER® iso685 device family - Modbus settings" at <https://www.bender.de/en/service-support/download-area/>

i *For setting device parameters externally via Modbus, the menu item **Allow** must be set in the **Write access** menu.*

9.4 Web server

The ISOMETER® devices of the isoxx685 family have an integrated web server which displays the device data on a web browser. This enables you to read out the measured values of the ISOMETER® devices and set parameters.

Preferably use the following browsers:

- Google Chrome
- Mozilla Firefox
- Microsoft Edge

The web server is accessed by entering the IP address of the ISOMETER® in the web browser. (Example: <http://192.168.0.5>). You can find the current IP address of the respective ISOMETER® in the device menu:

MENU: Info > Ethernet

9.4.1 Conventions



TCP connections

*A maximum of 5 TCP/IP connections can be used simultaneously. Only **one** device may access the web server at the same time. If several devices try to access the web server it may result in timeouts.*



Write access

*The write access is deactivated by default in the device menu (= **Deny**). In order to change parameters via the web server, write access must be allowed under*

MENU: Device settings > Interface > Write access

9.4.2 Functions

The web server offers the following functions:

- Visualisation
 - Display of device information (e.g. device type, software version, etc.)
 - Indication of current device settings
 - Indication of alarm messages
 - Indication of the Modbus information of the individual parameters
 - Indication of the interfaces in use
 - Overview of the current measured values
 - Detailed graphic representation of the insulation resistance (isoGraph)
 - Fast and easy visualisation, no programming knowledge required
- Parameter setting
 - Easy and fast setting of the device parameters
 - Easy assignment of and editing options for device texts
- Maintenance
 - Data storage of specific events for fast support by Bender Service

9.4.3 User interface

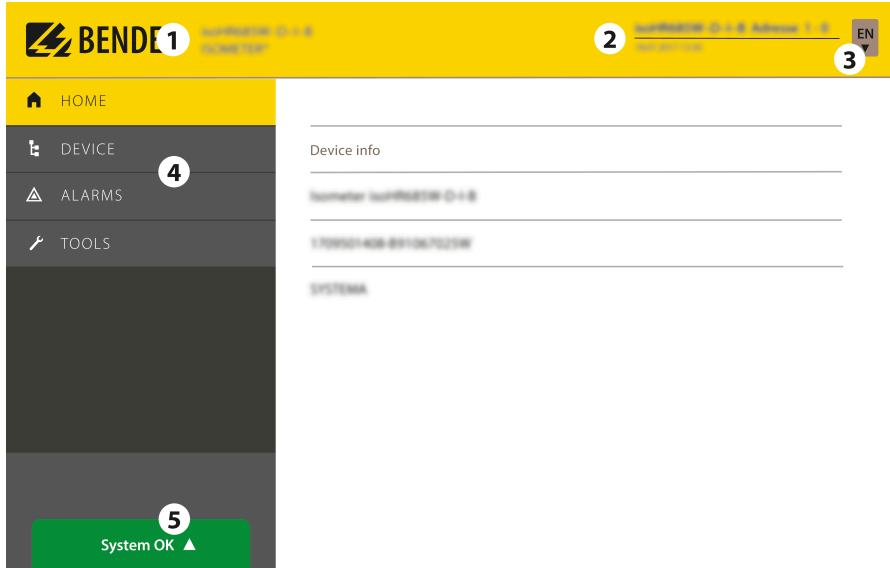

1	LOGO	Logo and device name
2	System information	Device address Date and time of the accessing browser system. The web user interface does not show the current time of the ISOMETER®. The current time of ISOMETER® the can be determined in the menu at DEVICE > Settings > Clock
3	Language	Changing the language settings
4	Browser menu	Main menu of the web server (first level) <ul style="list-style-type: none"> • START • DEVICE • ALARMS • TOOLS
5	System message	<div style="display: flex; align-items: center; margin-bottom: 10px;"> <div style="background-color: #28a745; color: white; padding: 5px 10px; border-radius: 5px;">System OK ▲</div> <div style="margin-left: 20px;">If there are pending alarms, click on the red button or go to menu point ALARMS to obtain further information.</div> </div> <div style="background-color: #dc3545; color: white; padding: 5px 10px; border-radius: 5px; display: inline-block;">Alarms 2 ▲</div>

9.4.4 Menu structure

The web menu is located at the left side of the browser window. Activated menu items are either highlighted in yellow or are written in yellow. Use the scroll bar on the right side to display further menu items.

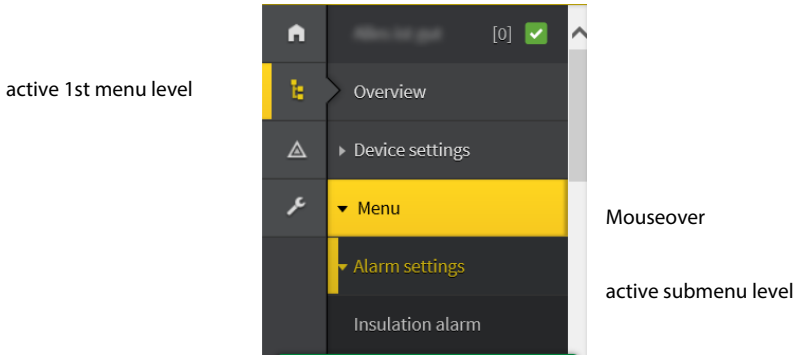

The menu structure is provided by the respective selected device. It is different depending on the respective device and on its menu structure. The structure of the device menu is described in the manuals of the respective device variants in the chapter “Settings”.

i Web menu – device menu

Web menu: Menu displayed by the web server via the browser.

Device menu: Menu available via the display on the device.

9.4.5 Parameter changes

Display of parameters in the standard versions

Inputs are located horizontally (orange frame) and the corresponding parameters vertically (blue frame). Currently set parameters are placed on the left side of the input field in grey font (red frame) and also appear in the entry field, provided that no change has been made.

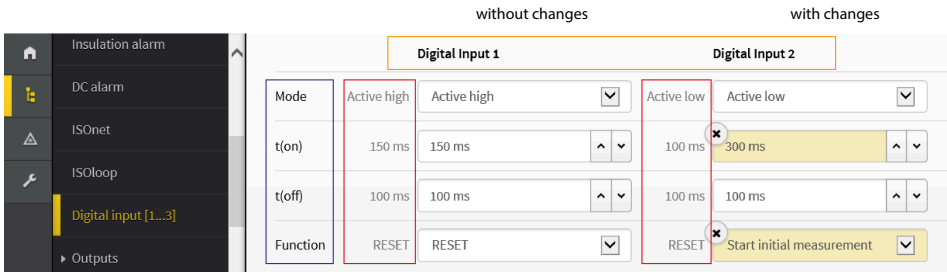

Figure: Display of the present values in a browser (cutout)

Display of parameters in the EDS menu area

In lists with many entries (for example channels displayed in the EDS system), channels are placed vertically as a list (orange frame) and the corresponding parameters horizontally (blue frame). Values highlighted in yellow show changes that have not yet been accepted by the system.

Channel [1 ... 12]

Name	Active	CT	CT monitor	IΔL	IΔn	Type	
Select all	<input type="checkbox"/>	on	TypeA	on	200 μA	100 mA	
1. BS bus: EDS 2 / Channel 1	<input type="checkbox"/>	✓ on	TypeA	on	5 mA	10 A	EDS440x
2. BS bus: EDS 2 / Channel 2	<input type="checkbox"/>	✗ changed name ✓ on	TypeA	✗ off	✗ 7 mA	✗ 1 A	EDS440x
3. BS bus: EDS 2 / Channel 3	<input type="checkbox"/>	✓ on	TypeA	on	5 mA	10 A	EDS440x
4. BS bus: EDS 2 / Channel 4	<input type="checkbox"/>	✓ on	TypeA	on	5 mA	10 A	EDS440x

Figure: Display of the channels in the EDS menu

Error detection in case of incorrect entry

In some cases the system expects certain characters to be entered, for example, CAPITAL LETTERS. In case of an incorrect entry, the corresponding input field is coloured in red.

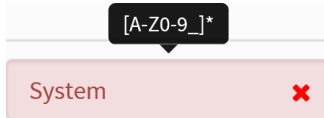

Figure: Incorrect text entry

Display of parameters with Modbus registers

To each parameter a Modbus register is assigned that can be addressed via the open interfaces Modbus TCP or Modbus RTU. These registers with their corresponding parameters can be displayed. Displaying them is activated via the menu: **TOOLS > Parameter addresses**.

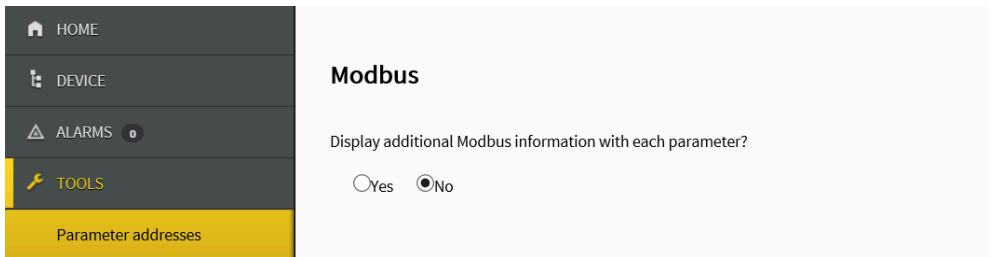

Figure: Activating the Modbus register display

Once the display has been activated, all parameters are shown with their corresponding Modbus registers.

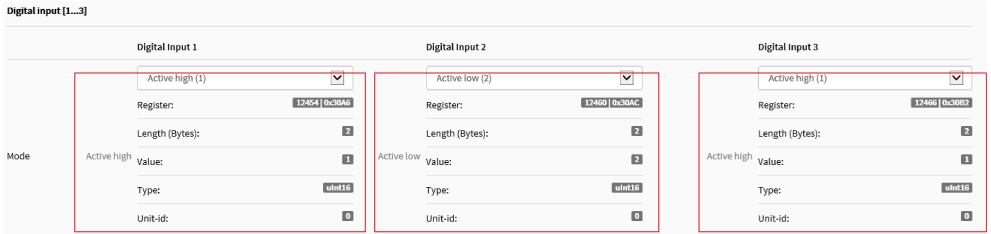
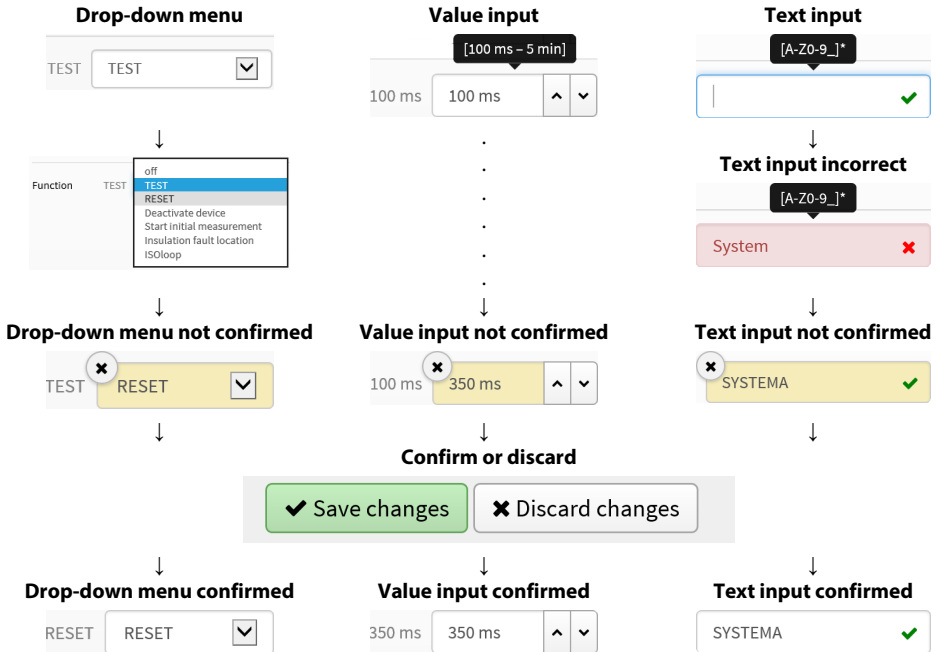

Figure: Display of Modbus registers

9.4.6 Changing parameters in a web browser

Changed values are highlighted in yellow in the input field. Changes can be made via drop-down menu, value input or text input.

The following figure shows application examples.



Possibilities of making entries via a web interface in iso685 devices

9.4.7 Changing parameters in the device menu when the web browser is open

When values are changed in the device menu of an iso685 device, these changed values are not automatically displayed on an already open browser page in the web server. The values that have been changed in the device menu, are highlighted in yellow on the web server, but the previously set value is still displayed.



Update of changes

When a new browser page is called up, the changes are already updated.

You have two options:

- You want to confirm the values changed on the device and that the web server displays the updated changes: To this end, click on the button **Save changes** at the lower edge of the screen.
- You do NOT want to confirm the values that were changed on the device. You want to restore the values set before the change and to discard the changes made via the device: To this end, click on the button **Discard changes** at the bottom of the screen.

9.4.8 Write access for parameter changes

You can deny the web server the write access for the ISOMETER® iso685, for example in order to prevent parameter changes via the web server.

You can deny write access in the menu or directly on the web server. If you want to allow write access again, you can only do so on the device itself.

MENU: Device settings > Interface > Write access

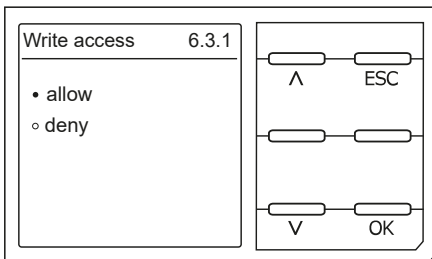

Factory set to **Deny**: A parameter change via the web server is only possible if you allow write access in the device.

9.5 BS bus

The BS bus is used to extend Bender measuring devices (e.g. ISOMETER®). It is an RS-485 interface with a specially developed protocol for Bender devices. On the BS bus, the transmission of alarm messages takes priority over the transmission of all other messages. For further information, refer to the BS bus manual (document number: D00278) at

<https://www.bender.de/en/service-support/download-area/>



CAUTION

When using interface converters, a galvanic separation is required.



The compatibility of the BS bus and the BMS bus is restricted!

9.5.1 Master-slave principle

The BS bus works according to the master-slave principle. The measuring device operates as the master, while all sensor devices operate as slaves. The master is responsible for the communication that is necessary for the measuring function. It also provides the required bus bias voltage for the operation of the BS bus.

9.5.2 Addresses and address ranges on the BS bus

Address 1 is assigned to the master. All sensor devices receive unique addresses starting with address 2, assigned in consecutive order without gaps. In the event of a device failure, a maximum gap of 5 addresses is permissible.

9.5.3 RS-485 specifications and cables

The RS-485 specification restricts the cable length to 1200 m and requires a daisy chain connection. The number of devices on the BS bus is only limited by the BS bus master.

Use twisted pair, shielded cables for bus cabling. For example, cable type J-Y(St)Y $n \times 2 \times 0.8$ is suitable. The shield must have a single-ended connection to earth. The BS bus must be terminated at both ends with terminating resistors (120 Ω , 0.25 W). The terminating resistors are connected in parallel to the terminals A and B. Some devices feature integrated terminating resistors and can be activated or deactivated via the **R** button.

9.5.4 Cable routing

The optimum cable routing for the BS bus is a double-terminated bus topology. The length of the branch line is limited to 1 m. These branch lines do not have to be terminated.

Bus topology examples:

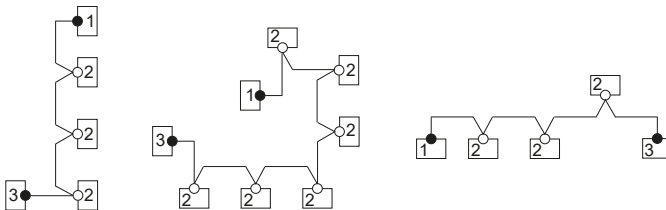

Termination

- 1 Master** Terminating resistor activated via switch on device (ON) or external terminating resistor between terminals A and B
- 2 Slave** Terminating resistor deactivated via switch on device (OFF)
- 3 Slave** Terminating resistor activated via switch on device (ON) or external terminating resistor between terminals A and B



ADVICE

Only the first and last device in one line may be terminated. Therefore, check all devices.

9.6 Modbus RTU

Modbus RTU is implemented on the RS-485 interface. The data transmission is binary/serial. Error-free and continuous data transmission must be guaranteed.

Measured values, messages and parameters are stored in virtual register addresses. Data can be read out with a read command written to a register address. With a write command, data can be written into a register address. The register addresses of the individual measured values and parameters can be found in the manual "iso685-... Modbus settings" at

<https://www.bender.de/en/service-support/download-area/>

9.7 isoData protocol

Data transmission is continuously carried out and can neither be interrupted by the data slave station nor be influenced in any other way (unidirectional). This protocol cannot be used in combination with the BMS protocol.

To evaluate the data by means of a PC or laptop, an USB/RS232-RS485 interface converter is required. Contact Bender Service to receive it.

Interface data:

- RS-485 interface galvanically separated from the device electronics
- Connection to terminals **A** and **B**.
- Maximum cable length 1200 m (in Mode 1)
- A data block is output after each valid measurement

Mode	Mode 1	Mode 2	Mode 3
Baud rate	9600	115200	115200
Data Bits	8	8	8
Stop bits	1	1	1
Parity	None	Even	Even
Flow control	None	None	None
TX Interval [ms]	10 * 1000	1000	1000
Bitmask support	No	No	Yes
Frame counter support	No	Yes	Yes
Field delimiter	0x0F	';' (0x3B)	';' (0x3B)
Start token	0x02	'!'	'!'
End token	0x03	n/a	n/a
Line end	<LF><CR>	<CR><LF>	<CR><LF>

i *The elements described in the table below have a defined length in the present implementation. However, isoData is a protocol that separates individual elements by means of delimiters (see **Field delimiter** in the table above). When these delimiters are used, a defined field length can basically be dispensed with. It is strongly recommended to implement external applications NOT based on field lengths, but based on element separators.*

isoData protocol table

Description	Length [Bytes]	Values	Unit	Example string	Position in data block		
					Mode 1	Mode 2	Mode 3
Data packet start character for Modes 2 and 3	1				-	0	0
Data packet start character for Mode 1	1	0x02 (control character = STX = Start of Text)		0x02	0	-	-
Available bitmask	8	Dependent on the fields included. (Bitmask)		FFFFFFFF	-	-	1
Date	8	Current device date		dd.mm.yy	-	-	2
Time	12	Current device time		hh:mm:ss.mmm	-	-	3
Insulation fault location	1	' ' = symmetrical fault '+' = fault on L1/+ '-' = fault on L3/-		x	-	1	-
Insulation fault location Detailed overview	4	Insulation fault percentage distribution from -100 ... +100	%	+123	-	8	4
Insulation fault location Brief overview	1	0 = AC fault 1 = DC- fault 2 = DC+ fault	k Ω	0	6	-	-
Insulation resistance Brief overview	6	R_f	k Ω	123456	1	-	-
Insulation resistance Limited overview	6	R_f Note: Value limited to 9.9 M Ω	k Ω	1234.5	-	2	-
Insulation resistance Detailed overview	9	R_f Note: Value limited to 9.9 M Ω		1234567.8	-	-	5
Measured value counter	2	Increased with each new measured value Integer with overflow at 99.	μ F (R Mode) nF (Z Mode)	12	-	11	6
Leakage capacitance C_g	4	R Mode [μ F] Z Mode [nF] Note: Z Mode is not supported	V	1234	-	3	7
Voltage U_n (VRMS) L1-L2	7	Voltage between phases L1 and L2 RMS values, unsigned	V	12345.6	-	-	8
Voltage U_n (VRMS) L1-L3	7	Voltage between phases L1 and L3 RMS values, unsigned	V	12345.6	-	-	9
Voltage U_n (VRMS) L2-L3	7	Voltage between phases L2 and L3 RMS values, unsigned	V	12345.6	-	-	10
Voltage U_n (VRMS)	5	Voltage between phases L1 and L2 RMS values AC system sign '' DC system sign always '+'	V	+1234	-	5	-
Voltage U_n (VRMS) L1-PE	5	Voltage between phase L1 and PE RMS values, Note: Sign always '+'	V	1234	-	6	11
Voltage U_n (VRMS) L2-PE	5	Voltage between phase L2 and PE RMS values, Note: Sign always '+'	V	1234	-	-	12
Voltage U_n (VRMS) L3-PE	5	Voltage between phase L3 and PE RMS values, Note: Sign always '+'	V	1234	-	7	13
Measurement quality	3	Quality of measured value 0 % = poor quality => change profile 100 % = good quality => profile matches application	%	100	-	-	14
Voltage DC-PE	4	DC offset voltage to earth	V	+123	-	-	15
Alarm messages	4	[Hexadecimal] (without leading "0x") The alarms are included in this value with the OR function.	BIT	1234	-	10	16

Description	Length [Bytes]	Values	Unit	Example string	Position in data block		
					Mode 1	Mode 2	Mode 3
Bit 2: Device error	n/a	0x0002		Bitmask	-	+	+
Bit 3: Prewarning Insulation resistance R_f on L1/+	n/a	0x0004		Bitmask	-	+	+
Bit 4: Prewarning Insulation resistance R_f on L2/-	n/a	0x0008		Bitmask	-	+	+
Bit 5: Prewarning Insulation resistance R_f sym.	n/a	0x000C		Bitmask	-	+	+
Bit 6: Alarm Insulation resistance R_f on L1/+	n/a	0x0010		Bitmask	-	+	+
Bit 7: Alarm Insulation resistance R_f on L2/-	n/a	0x0020		Bitmask	-	+	+
Bit 8: Alarm Insulation resistance R_f sym.	n/a	0x0030		Bitmask	-	+	+
Bit 9: Prewarning Insulation impedance Z_f	n/a	0x0040 Note: Currently not supported		Bitmask	-	+	-
Bit 10: Alarm Insulation impedance Z_f	n/a	0x0080 Note: Currently not supported		Bitmask	-	+	-
Bit 11: Alarm Undervoltage U_n	n/a	0x0100 Note: Currently not supported		Bitmask	-	+	-
Bit 12: Alarm overvoltage U_n	n/a	0x0200 Note: Currently not supported		Bitmask	-	+	-
Bit 13: System test message	n/a	0x0400		Bitmask	-	+	+
Bit 14: Device start with alarm	n/a	0x0800 Note: Currently not supported		Bitmask	-	+	-
Alarm message: insulation fault Brief overview	1	0 == No alarm 1 == Alarm 1 2 == Alarm 2 3 == Alarm 1 + Alarm 2	Number	0	5	-	-
Temperature in the device	4	Device temperature preceded by '+' or '-' sign	°C	+100	-	-	17
System frequency	3	0	Hz	123	-	-	18
Response value 1	6	R_f Note: For response values $\geq 1 \text{ G}\Omega$, '999999' is output	k Ω	123456	2	-	19
Response value 2	6	R_f Note: For response values $\geq 1 \text{ G}\Omega$, '999999' is output	k Ω	123456	3	-	20
System type	3	['DC' ' AC' '3AC'] ATTENTION: Observe the blank space preceding AC and DC!		3AC	-	-	21
Relays (K1,K2), states	1	0 -> K1 == off, K2 == off 1 -> K1 == on, K2 == off 2 -> K1 == off, K2 == on 3 -> K1 == on, K2 == on		0	4	-	22
Impedance	6	Z_f	k Ω	1234.5	-	4	-
Unsymmetrical insulation resistance, approximated	6	R_{UGF}	k Ω	1234.5	-	9	-
Insulation measurement ADC value	5	ADC value in digits		12345	-	-	-

Description	Length [Bytes]	Values	Unit	Example string	Position in data block		
					Mode 1	Mode 2	Mode 3
Active measuring profile	2	01 - Power circuits 02 - Control circuits 03 - Generator 04 - High capacitance 05 - Inverter > 10Hz 06 - Inverter < 10Hz 07 - Customer-specific profile 08 - Service profile	Number	01	-	-	23
Frame counter	1	Counts continuously from 0 to 9.		1	-	-	24
String end	2	String end! ATTENTION: Standard mode sends <LF><CR> i. e. the two characters are in reverse order.		<CR><LF>	+	+	+

10 Insulation fault location

10.1 General description

An additional function of the ISOMETER® in combination with the EDS is the selective insulation fault location. The insulation faults detected in the IT system by the ISOMETER® can be located by means of an EDS and a measuring current transformer. For further information regarding the function principle of the insulation fault location, refer to chapter "Insulation fault location", page 13.

10.2 Required settings for insulation fault location

Connecting and commissioning the system consisting of ISOMETER® and EDS correctly

For further information regarding the connection of the EDS, refer to "Connection of EDS44x/IOM441 to the ISOMETER®", page 27 and the corresponding manual of the EDS.

Setting locating current and EDS mode

These settings can be made either during initial commissioning (see "Initial commissioning", page 33) or in the device menu of the ISOMETER® (see "Insulation fault location", page 95).

For further information regarding the locating current for insulation fault location, refer to chapter "Current", page 60.

For further information regarding EDS modes, refer to chapter "Mode", page 60.

10.3 Indication on the display

The active insulation fault location is shown on the display of the ISOMETER®. For further information, refer to chapter "Insulation fault location", page 95.

10.4 Starting and stopping the insulation fault location

The insulation fault location can be started and stopped via different interfaces:

- Shortcut button **EDS**
If the device is started continuously, it measures until it is manually stopped via the shortcut button.
- Device menu
- Modbus
- Web server
- Digital input

For further information regarding start and stop conditions of the insulation fault location, refer to chapter "Mode", page 60.

11 Special functions for coupled IT systems

11.1 Particularities when monitoring coupled IT systems

When using ISOMETER®s in IT systems, make sure that only one active ISOMETER® is connected in each interconnected system. If several ISOMETER®s are to be connected to the IT system, ensure that only one ISOMETER® is active in the IT system via system isolation using the digital input or Ethernet (ISONet function). If IT systems are interconnected via coupling switches, make sure that ISOMETER®s not currently used are disconnected from the IT system and deactivated.

IT systems coupled via diodes or capacitances may also influence the insulation monitoring process so that a central control of the different ISOMETER®s is required.

11.2 System isolation via digital input with two coupled systems

i In order to deactivate the ISOMETER® iso685-x-P via one of the digital inputs, the coupling switch must have a free contact.

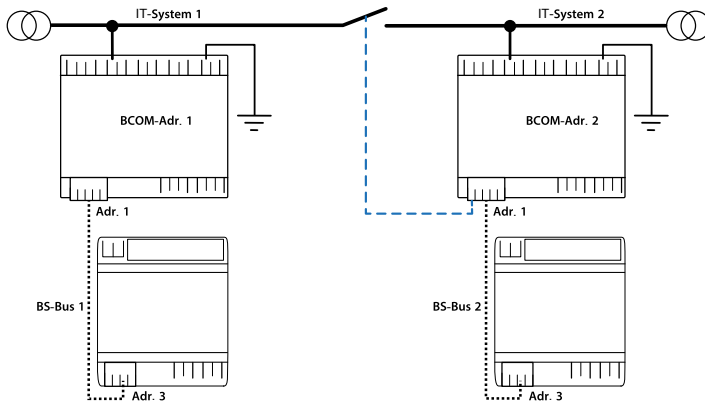

Via the X1 connector, the ISOMETER® can be isolated from the IT system and the measuring functions can be deactivated. Therefore, the function of the digital input in use has to be set to Device inactive.

If the digital input used for this function is selected, the connectors **L1/+**, **L2**, **L3/-** are deactivated via internal system isolating switches, the measuring function stops and the following message appears on the display:

Device inactive. Device separated.

Stored fault messages are reset when the cause of the fault has been eliminated (reset function).

If the digital input is no longer selected, first the connection to the IT system is restored and afterwards, an entirely new measuring cycle for the insulation monitoring starts. This function can be used to disconnect the second ISOMETER® selectively in coupled IT systems via the auxiliary contact of the coupling switch.

11.3 System isolation via ISOnet

The ISOnet function ensures via an Ethernet connection that only one ISOMETER® of the interconnection is active when several ISOMETER®s are connected to an IT system.

For several ISOMETER®s to be able to measure in the same ISOnet interconnection, the settings for the BCOM system name and the BCOM subsystem have to be the same. Only the device address has to be different. If this is not taken into account, the ISOnet function will not work.

If the ISOnet function is deactivated in an ISOMETER® in an ISOnet interconnection, it will measure continuously and will not forward measuring commands to the next device in the interconnection.

In comparison to a solution with coupling switches and function input, the response time will be extended because the measurement in the IT system is not carried out continuously.

The addresses of the ISOMETER®s in the ISOnet interconnection can be selected at will. The addresses do not have to be subsequent but they have to differ from each other.

If in addition to the ISOnet interconnection the digital inputs are wired and a device is deactivated via a digital input, the device will forward the measuring authorisation until the signal at the digital input disappears. Afterwards, it participates again in the measuring interconnection.



Configuration

Maximum number of devices in an ISOnet interconnection: 20 devices The IP address of the standard gateway must suit the subnet mask, so that the ISOnet function can operate correctly.

11.3.1 System connection diagrams

ISOnet with direct Ethernet connection

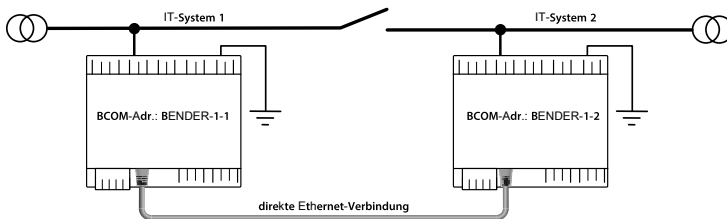

ISOnet group with switch

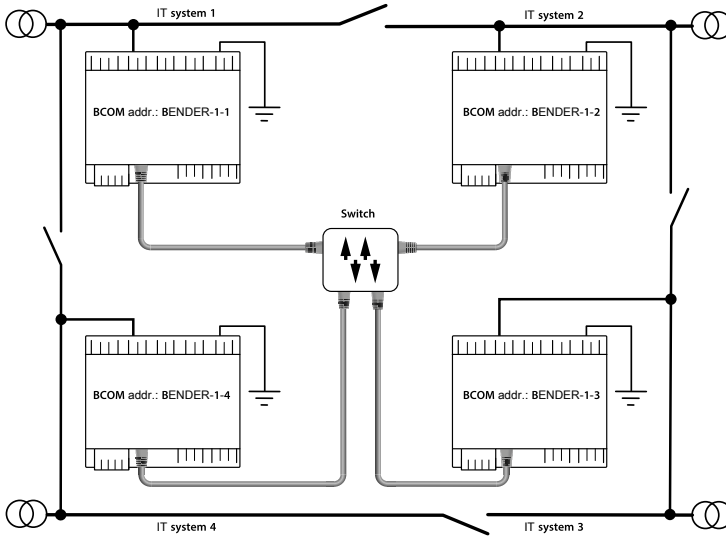

11.3.2 Configuration and function

The ISOnet function requires the setting **BCOM** in the menu:

MENU: Alarm settings > ISOnet > ISOnet

The ISOnet function of all ISOMETER®s existing in the system has to be activated and the number of devices has to be determined in the menu:

MENU: Alarm settings > ISOnet > Number of devices

Also the parameters of the Ethernet and BCOM have to be set so that the devices in the ISOnet interconnection can communicate with each other.

After starting the system, the devices initialise. The initialisation phase ends when the configured number of devices has been reached. Then, the first device with the lowest address starts with a measuring cycle. When an ISOMETER® has finished one measuring cycle, the authorisation for insulation measurement is forwarded to the ISOMETER® with the next higher address. While one ISOMETER® is measuring, all other ISOMETER®s are separated from the system via internal system isolation switches. By limiting to one subsystem it is possible to have several ISOnet interconnections running in one system.

If a single device fails, the remaining ISOMETER®s continue the ISOnet operation. For the failure of one device, two scenarios are possible:

- A device fails during a measuring procedure.
After timeout, another device takes over the measuring function.
In this way, all devices monitor each other.
- The device fails in the inactive mode.
When forwarding the measuring authorisation, the device is skipped and the next device carries out the measurement.

If a device that has failed before returns, it is taken into the interconnection again and can carry out a measurement during the next run.

**Parallel operation ISOnet and ISOLoop**

ISOnet and ISOLoop must not be activated together, otherwise a measurement is not guaranteed.

11.3.3 ISOnet priority

This function makes it possible to give the device in ISOnet mode a permanent priority in the system or to take over the priority from another device. While the function is set to active, all other devices in ISOnet mode are inactive. The last requesting device always has priority. After 12 hours, the device automatically returns to normal mode.

With the ISOnet priority function, priority can be requested or yielded in:

MENU: Control > ISOnet priority

11.4 ISOLoop

Ring systems are a special type of coupled systems in which all systems can be coupled to form a ring interconnection. The ISOLoop function ensures that, in a system with several insulation monitoring devices, one device is always actively measuring. The devices that work in an ISOLoop configuration are combined into a group. Within the group, digital inputs are used to control which devices are currently working together in a team. Within the team, the device with the lowest BCOM address takes over the measuring task.

If the systems are coupled via the coupling switches, the devices receive a signal via the digital input informing them that they are now working together as a team. If only the upper coupling switch is closed, device 1 and device 2 are in a team and device 1 takes over the measuring task. If all coupling switches are closed, all four devices are in one team and device 1 takes over the measuring task.

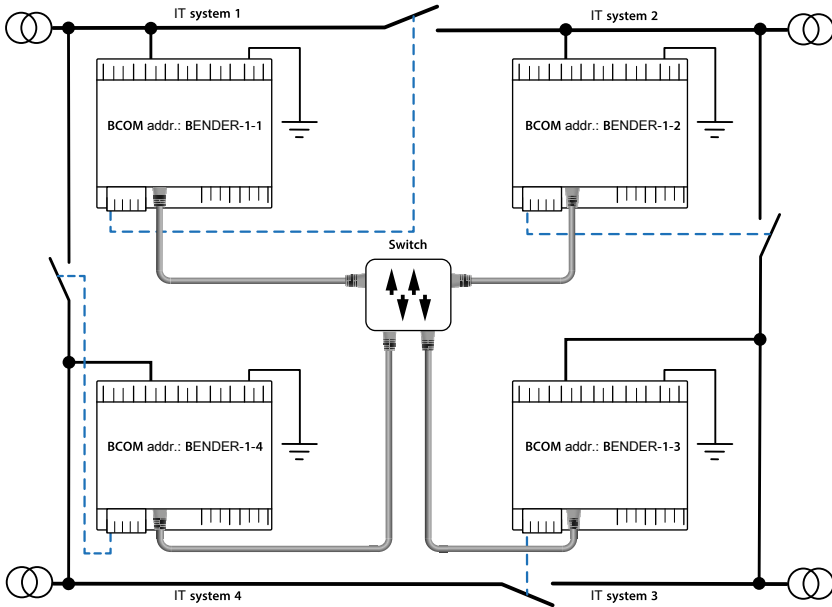

The measuring device with the lowest BCOM address in a team (in the example, device BENDER-1-1) distributes its currently measured insulation value to all team members (here device BENDER-1-2). The parameter **Measured value subscription** can be used to define whether this shared measured value is to be shown on the respective device. If this function is activated, device 2 would also report an insulation alarm 1 and 2 based on the selected alarm thresholds. This function is activated by default.

The basis of the ISOloop function is the combination of several ISOMETER®s to form an interconnection. The grouping of up to 10 ISOMETER®s is carried out with a separate software, the *BCOM Group Manager*. The program can be downloaded from the Bender website or via the web server:

- Website: <https://www.bender.de/en/service-support/download-area/>
- Web server: Menu > Settings > File \wwwroot\groupcfg.zip

The tested setup file can be executed on any Windows PC in the network.

i **Parallel operation ISOnet and ISOloop**

ISOnet and ISOloop should not be activated simultaneously since the two functions are opposed. In ISOnet mode, the measuring task is assigned cyclically to all devices in the system, while in ISOloop mode, the measuring task is always assigned to the device with the lowest address within a defined interconnection.

11.4.1 Preparing the devices in an interconnection

In order to enable the cooperation of different devices within an interconnection, each device must be provided with a valid BCOM address. The respective system name must be configured uniformly for all devices.

i **BCOM system name configuration**

All devices in the interconnection must have a common device name.

Information on the configuration of BCOM in the device menu:

- Chapter BCOM in section Interfaces

Information about BCOM:

- Chapter “BCOM”, page 83 in this manual
- BCOM manual (D00256) at <https://www.bender.de/en/service-support/download-area/>

11.4.2 Creating groups with the *BCOM Group Manager*

The *BCOM Group Manager* provides help for creating ISOMETER® groups. Open the program and select **ISOloop** mode.

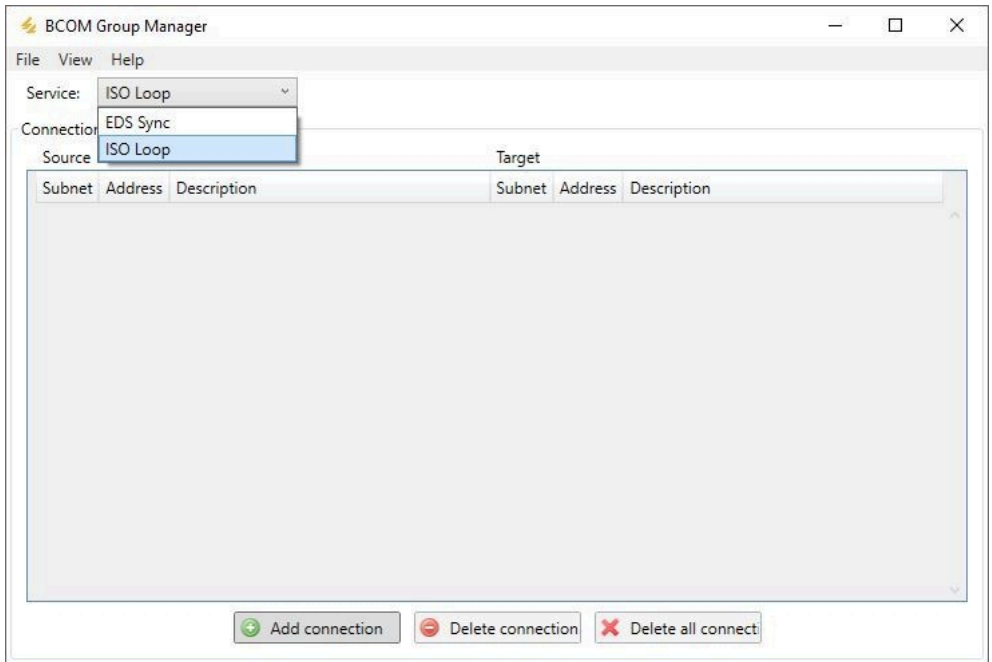

Creating groups



Add a device to the group.



Remove a device from the group.



Remove all devices from the group.

Switching rules

Source and target define the two devices that work together in a team when the coupling switch connected to the source is closed.

Example: The upper coupling switch is connected to device 1 => source is device 1 and target is device 2.

Each combination of subnet and device address may only exist once as source and target in an interconnection. Each device requires exactly and exclusively one other device as target.

The **Connection List** must contain all connections that exist in the installation. The following figure shows the connections for the above example.

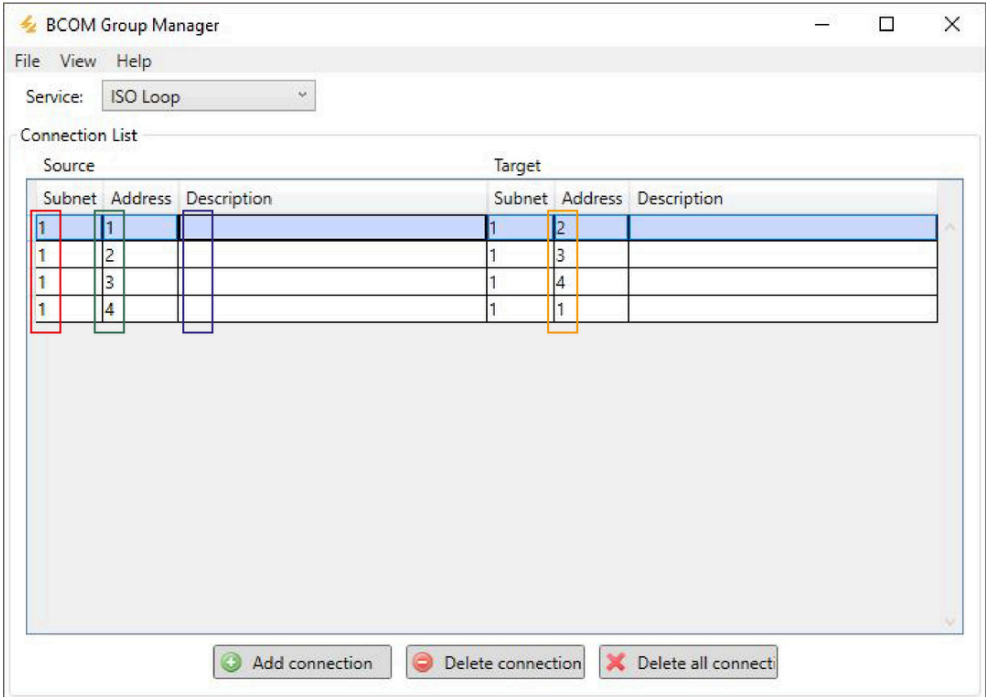

The screenshot shows the BCOM Group Manager interface. At the top, there is a menu bar with 'File', 'View', and 'Help'. Below the menu bar is a 'Service:' dropdown menu set to 'ISO Loop'. The main area is titled 'Connection List' and contains a table with the following structure:

Source			Target		
Subnet	Address	Description	Subnet	Address	Description
1	1		1	2	
1	2		1	3	
1	3		1	4	
1	4		1	1	

Below the table are three buttons: 'Add connection' (with a green plus icon), 'Delete connection' (with a red minus icon), and 'Delete all connect' (with a red X icon).

	Subnet specification in an interconnection (different subnets possible)
	A maximum of 10 addresses (devices) in one interconnection
	Freely selectable device description
	Target address for loop information. Each device requires a target in the interconnection.

After all settings of the group have been made, the configuration file must be saved.

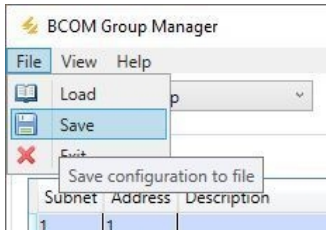

File name of the configuration file

The name of the configuration file of the ISOLoop interconnection is **grp_0102.cfg**. The name must not be changed, since every ISOMETER® receives the information about the ISOLoop interconnection from a file with exactly this name. For documentation purposes, we recommend saving the file in a zip file, the name of which can then be changed.

Transferring the configuration file to an ISOMETER®

The configuration file is installed via the web user interface of the iso685-x-P device in the browser of a computer in the network. Proceed as follows:

1. Apply a supply voltage to all correctly connected devices in the interconnection.



All devices in the interconnection must be switched on

The ISOLoop information is transferred from device to device according to an address sequence defined in the configuration. Therefore, when uploading the configuration file, all devices in the interconnection must be switched on and connected to the network.

2. Parameterise the Ethernet settings for all devices and check that the devices can communicate via Ethernet.
3. Parameterise the BCOM addresses created in the Group Manager for all devices.
4. Activate the ISOLoop function on all devices.
5. Enter the IP address of the device to which you want to upload the configuration file in the browser window.
6. Navigate to the following menu item:

DEVICE > Menu > Settings > File

The following input window appears in the content area of the COMTRAXX® user interface:

Hochladen

1. Wählen Sie einen Zielordner

2. Wählen Sie die Datei zum Hochladen aus Keine ausgewählt

3. Zielpfad

4. Hochladen

7. Select target folder **group** (1.).
 8. Select file **grp_0102.cfg** in the corresponding folder of your source PC (2.).
 9. In the target path line (3.), the following must appear after the symbol:
\group\grp_0102.cfg
 10. Start the upload by pressing the **Save** button (4.).
- ✓ The configuration settings of the interconnection are automatically distributed after completing the procedure.
 - ✓ After completion, the file is available for download in the download area of the device:

Herunterladen	Aktualisieren
\group\grp_0101.cfg	Herunterladen
\group\grp_0102.cfg	Herunterladen
\text\indtxt.bin	Herunterladen
\tools\GroupCfg.zip	Herunterladen

11.4.3 Configuration and function on the ISOMETER®

The ISOLOOP function is enabled or disabled in the menu. The function must be activated and configured for all ISOMETER®s in the system that have to work synchronously.

To enable the devices in the ISOLOOP interconnection to communicate with each other, the Ethernet settings (DHCP on or IP address, subnet mask and default gateway) must be made in addition to the ISOLOOP function.

1. Activate ISOLOOP function at:
MENU: Alarm settings > ISOLOOP > ISOLOOP
2. Select ISOLOOP as function at:
MENU: Alarm settings > Inputs > Digital X

i **ISOloop function**
 If the **ISOloop** function is not activated before the Group Manager file is uploaded, or if the devices do not have valid IP/BCOM parameters, the file is not automatically distributed in the system.

11.5 EDSsync

In combination with the EDS, the ISOMETER® iso685-x-P offers the function of selective insulation fault location. For this purpose, the ISOMETER® generates a periodic locating current after the measured value has fallen below the set response value R_{an2} (**ALARM 2 LED**).

It is limited by the ISOMETER® depending on the settings. The insulation fault is selectively located by means of the EDS and the measuring current transformer connected to it. The locating current flows from the locating current injector via the live lines to the insulation fault position taking the shortest way. From there, it flows through the insulation fault and the **PE** conductor back to the ISOMETER®. This locating current pulse is detected by the measuring current transformer on the insulation fault path and signalled by the connected EDS.

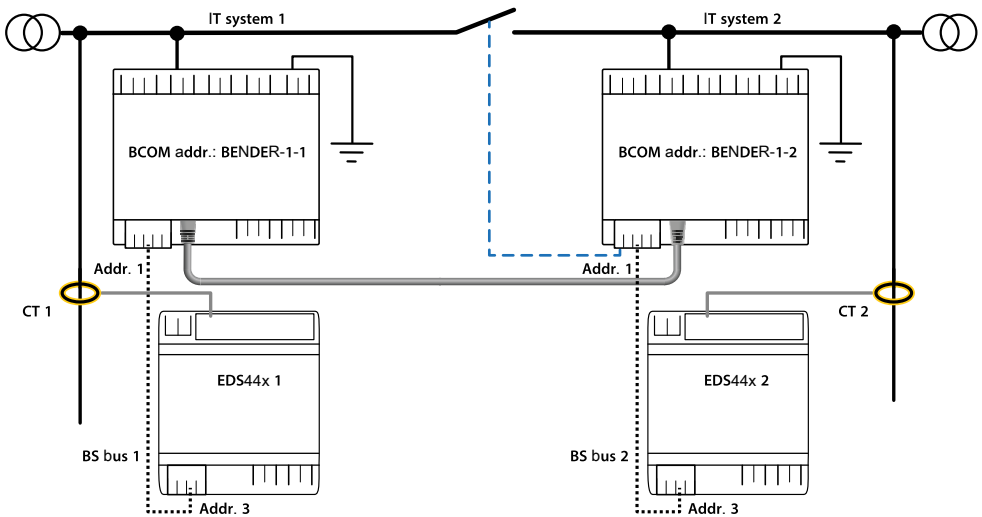

Each ISOMETER® iso685-x-P manages its EDS devices and sends its EDS devices the trigger signals required for insulation fault location via its BS and BB bus. The EDSsync function must be activated so that EDS devices which are connected to other iso685-x-P can also receive trigger signals in coupled systems.

The **EDSsync** function ensures that in an installation with several iso685-x-P insulation monitoring devices, all connected EDS participate in the insulation fault location. The devices that work in an EDSsync configuration are combined into a group.

The **EDSsync** function can be combined with the functions

- System isolation via digital input
- System isolation via ISONet
- ISOloop

**EDSync for EDS441-LAB**

EDSync function cannot be combined with EDS441-LAB.

11.5.1 Preparing the devices in an interconnection

In order to enable the cooperation of different devices within an interconnection, each device must be provided with a valid BCOM address. The respective system name must be configured uniformly for all devices.

**BCOM system name configuration**

All devices in the interconnection must have a common device name.

Information on the configuration of BCOM in the device menu:

- Chapter BCOM in section Interfaces

Information about BCOM:

- Chapter "BCOM", page 83 in this manual
- BCOM manual (D00256) at <https://www.bender.de/en/service-support/download-area/>

11.5.2 Creating groups with the BCOM Group Manager

The *BCOM Group Manager* provides help for creating ISOMETER® groups. Open the program and select **EDSync** mode.

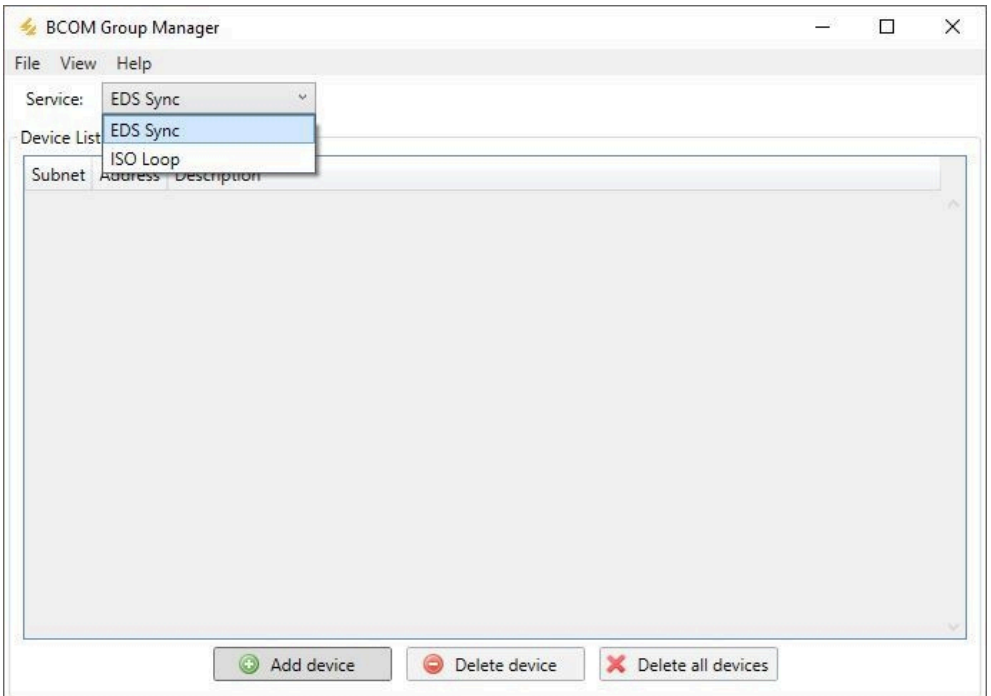

Creating groups

- + Add connection
- Delete connection
- X Delete all connect

Add a device to the group.

Remove a device from the group.

Remove all devices from the group.

Switching rules

The **Device List** must contain all devices that are to be synchronised in the interconnection. The following figure shows a **Device List** in which two devices are grouped. Devices from different subnets can also be combined into a group. Each combination of subnet and device address may only exist once in an interconnection.

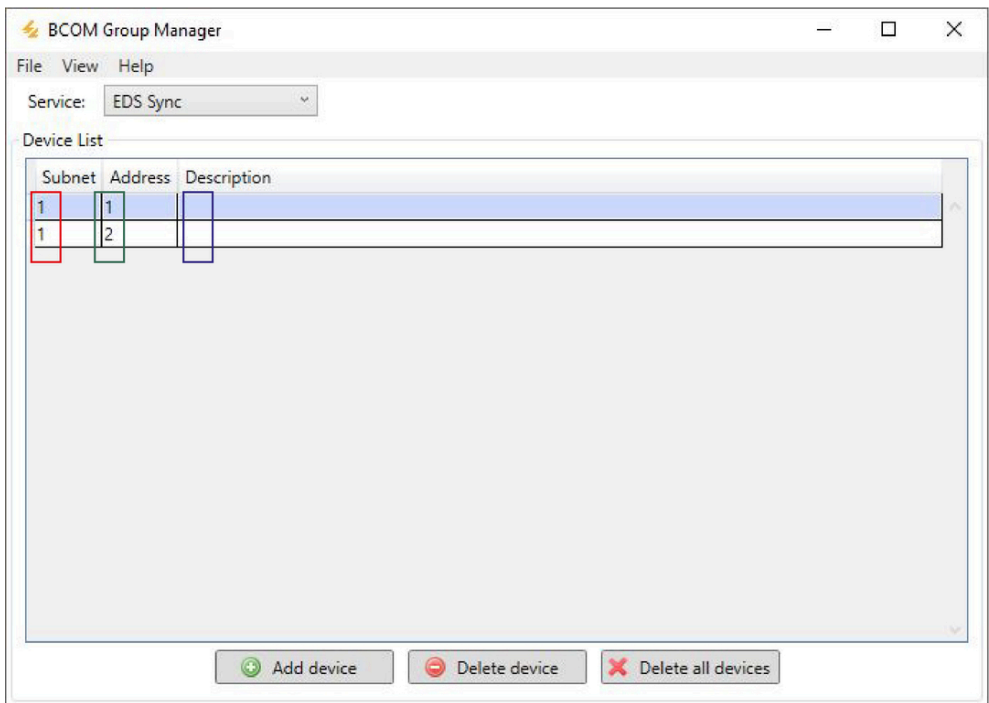

BCOM Group Manager

Service: EDS Sync

Device List

Subnet	Address	Description
1	1	
1	2	

+ Add device

- Delete device

X Delete all devices

	Subnet specification in an interconnection (different subnets possible)
	A maximum of 10 addresses (devices) in one interconnection
	Freely selectable device description

After all settings of the group have been made, the configuration file must be saved.

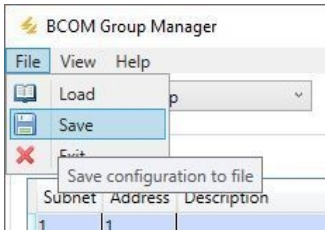

File name of the configuration file

The name of the configuration file of the EDSSync interconnection is **grp_0101.cfg**. The name must not be changed, since every ISOMETER® receives the information about the EDSSync interconnection from a file with exactly this name. For documentation purposes, we recommend saving the file in a zip file, the name of which can then be changed.

Transferring the configuration file to an ISOMETER®

The configuration file is installed via the web user interface of the iso685-x-P device in the browser of a computer in the network. Proceed as follows:

1. Apply a supply voltage to all correctly connected devices in the interconnection.
2. Parameterise the Ethernet settings for all devices and check that the devices can communicate via Ethernet.
3. Parameterise the BCOM addresses created in the Group Manager for all devices.
4. Activate the EDSSync function on all devices.
5. Enter the IP address of the device to which you want to upload the configuration file in the browser window.
6. Navigate to the following menu item:

DEVICE > Menu > Settings > File

The following input window appears in the content area of the COMTRAXX® user interface:

Hochladen

1. Wählen Sie einen Zielordner

2. Wählen Sie die Datei zum Hochladen aus

3. Zielpfad

4. Hochladen

7. Select target folder **group** (1.).

8. Select file **grp_0101.cfg** in the respective folder of your source PC (2.).
 9. In the target path line (3.), the following must appear after the symbol:
\group\grp_0101.cfg
 10. Start the upload by pressing the **Save** button (4.).
- ✓ The configuration settings of the interconnection are automatically distributed after completing the procedure.
 - ✓ After completion, the file is available for download in the download area of the device:

Herunterladen	Aktualisieren
\group\grp_0101.cfg	Herunterladen
\group\grp_0102.cfg	Herunterladen
\text\indtxt.bin	Herunterladen
\tools\GroupCfg.zip	Herunterladen

11.5.3 Activating the function on the ISOMETER®

The EDSSync function is activated or deactivated in the menu at:

MENU: EDS > General > EDS sync

The function must be activated on all ISOMETER®s in the system that have to work synchronously.

To enable the devices in the EDSSync interconnection to communicate with each other, the correct Ethernet settings must have been made at:

MENU: Device settings > Interface > Ethernet

In addition, the BCOM addressing must have been carried out correctly in the menu at:

MENU: Device settings > Interface > BCOM

12 Alarm messages

12.1 General alarms

Alarm messages are activated as soon as the device has been switched on and can be signalled immediately.

Message	Description	Actions
Undervoltage	Operating outside the specified supply voltage range	<ul style="list-style-type: none"> Check supply voltage.
Overvoltage	Operating outside the specified supply voltage range	<ul style="list-style-type: none"> Check supply voltage.
Check L1-L2-L3 for correct connection! [LEDs ALARM 1 , ALARM 2 flash alternately]	No low-resistance connection between the line conductors	<ul style="list-style-type: none"> Check the wiring of terminals L1/+, L2 and L3/- to the IT system. Press the button TEST. Check nominal system voltage. Check the back-up fuses. Check set system type.
Check E-KE connections for interruptions! [LEDs ALARM 1 , ALARM 2 flash in common mode]	No low-resistance connection between terminals E and KE to earth (PE)	<ul style="list-style-type: none"> Check the wiring of terminals E and KE to earth (PE). Press the button TEST.
Profile not suitable for the application!	Wrong profile selected for this application	<ul style="list-style-type: none"> Check measured system capacitance or mains frequency in the menu Info. Select another profile taking the characteristics into consideration.
Loads on X1 too high!	Sum of the external loads on X1 is too high.	<ul style="list-style-type: none"> Check load at X1.+, X1.Q1 and X1.Q2. Check ambient temperature.
Check date and time!	Date and time have not yet been set.	<ul style="list-style-type: none"> Set local date and time (in case of voltage failure buffer for three days).
No DHCP server found!	Connection problem at the Ethernet interface	<ul style="list-style-type: none"> Check cable connection at the Ethernet interface. Check the DHCP server's availability. Check the DHCP's interface configuration in the device.
Device error x.xx [LED SERVICE is lit]	Internal device error	<ul style="list-style-type: none"> Press the button TEST. Switch the supply voltage off and on. Contact Bender Service.
DC offset voltage	There is a DC offset voltage in the system.	<ul style="list-style-type: none"> Check insulation fault and eliminate fault of DC components.
Synchronising ...	The device synchronises over a longer period of time. (longer than five minutes)	<ul style="list-style-type: none"> Restart.
BCOM connection interrupted!	No connection to devices can be made within the BCOM system due to a) an interrupted bus conductor, b) incorrect Ethernet settings, c) incorrect grouping.	<ol style="list-style-type: none"> Connect bus conductor correctly. Correct Ethernet settings. Restore configuration using the BCOM Group Manager.
Service mode active! [LED SERVICE is lit]	The device is in maintenance condition.	<ul style="list-style-type: none"> Contact Bender Service.

12.2 Measured value alarms

Alarm messages are activated as soon as the device has been switched on and can be signalled immediately.

Message	Description	Actions
Insulation fault prewarning [LED ALARM 1 is lit]	An insulation fault exists. The insulation resistance falls below the response value R_{an1} .	<ul style="list-style-type: none"> • Watch insulation resistance in the monitored system. • Reset fault message by pressing the RESET button.
Insulation fault main alarm [LED ALARM 2 is lit]	An insulation fault exists. The insulation resistance falls below the response value R_{an2} .	<ul style="list-style-type: none"> • Eliminate insulation fault in the system being monitored. • Reset fault message by pressing the RESET button.
DC offset voltage	There is a DC offset voltage in the system.	<ul style="list-style-type: none"> • Check insulation fault and eliminate fault of DC components.

12.3 ISOnet

These messages become active only after the ISOnet function has been activated.

Alarm	Description	Actions
Disturbance ISOnet	The Ethernet connection of the isometer is disturbed (e.g. by a defective cable or the failure of a switch).	<ul style="list-style-type: none"> • Check Ethernet connection. • Check device function. • Switch the supply voltage off and on.
Failure address	Active devices in the ISOnet interconnection detect that one or more devices can no longer be reached. This message is the parallel information on the active devices that corresponds to the message Disturbance, ISOnet .	<ul style="list-style-type: none"> • Check Ethernet connection. • Check device function.
Num.ISOnet devices	The configuration of the present ISOnet devices and that of the configured ISOnet devices differ.	<ul style="list-style-type: none"> • Check settings. • Check Ethernet connection.

12.4 ISOLoop

These messages become active only after the ISOLoop function has been activated.

Alarm message	Description	Actions
The ISOLoop configuration is not uniform!	The ISOLoop group configuration is not consistent for all the devices in this group or one of the devices in the group is not configured.	<ul style="list-style-type: none"> • Ensure that all the devices of the group to be configured can communicate (correctly configured and connected BCOM and Ethernet connections) • Then upload ISOLoop configuration via the web server on one device
ISOLoop configuration is faulty!	Addresses of the group configuration (system, subsystem and device addresses) do not correspond to the addresses on the devices of this group.	
ISOLoop configuration not found!	There is no ISOLoop configuration on this device.	
Error while distributing the ISOLoop configuration!	The ISOLoop configuration could not be distributed to all the devices (devices were not switched on or faulty BCOM connection) OR this function was not activated when the configuration file was uploaded OR this function was not activated on every device when the configuration file was uploaded.	

12.5 EDS44x

Alarm message	Description	Action
Insulation fault location disturbed!	Interferences during insulation fault location, possible causes: <ul style="list-style-type: none"> • Low-frequency residual currents • External magnetic fields 	<ul style="list-style-type: none"> • Identify interference sources and eliminate them
insulation fault x mA	If an insulation fault is located, the message Insulation fault 5 mA appears on the display. The level of the locating current gives information regarding the faulty outgoing circuit. The higher the locating current, the lower the insulation resistance on the detected channel.	<ul style="list-style-type: none"> • Determine cause of the insulation fault and eliminate it
Interference CT connection	A measuring current transformer has not been connected correctly or does not work.	<ul style="list-style-type: none"> • Check wiring of the measuring current transformers • Check device function • Start new search for EDS channels • Deactivate channel without CT
CT short circuit	CT connection fault. Possible causes: <ul style="list-style-type: none"> • Measuring current transformers defective • Power supply cable short-circuited 	<ul style="list-style-type: none"> • Replace defective measuring current transformers • Check cables
Residual current	The set response value of the residual current has been exceeded on one channel.	<ul style="list-style-type: none"> • Determine cause of the exceeded residual current and eliminate fault.

12.6 EDSsync

Alarm message	Description	Action
EDSsync configuration is not uniform!	The EDSsync group configuration is not uniform for all devices in the group OR one of the devices has no configuration	Ensure that all the devices of the group to be configured can communicate (correctly configured and connected BCOM and Ethernet connections). Then upload EDSsync configuration via the web server on one device.
EDSsync configuration is faulty!	The addresses defined in the EDSsync configuration (system - subsystem - device address) do not correspond to the addresses set on the devices of this group.	Check BCOM settings on all devices in this group and, if necessary, adjust to group configuration or make sure that all devices in the group to be configured are able to communicate (correctly set and BCOM and Ethernet connection established). Afterwards, upload EDSsync configuration to a device via the web server.
EDSsync configuration was not found!	There is no EDSsync configuration on this device.	Ensure that all the devices of the group to be configured can communicate (correctly configured and connected BCOM and Ethernet connections). Then upload EDSsync configuration via the web server on one device.
Error while distributing the EDSsync configuration!	The EDSsync configuration could not be distributed to all the devices OR this function was not activated when the configuration file was uploaded OR this function was not activated on every device when the configuration file was uploaded.	

13 Technical data

13.1 Factory settings

System			
System type	3AC		
System profile	Power circuits		
Coupling monitoring	on		
Start-up delay t_{start}	0 s		
Response values/alarms			
Response value R_{an1} (ALARM 1)	40 k Ω		
Response value R_{an2} (ALARM 2)	10 k Ω		
DC alarm	off		
DC offset voltage for DC alarm	65 V		
Fault memory	off		
Digital inputs	1	2	3
Mode (operating mode)	High-active	Low-active	High-active
Function	TEST	RESET	Deactivate device
Digital outputs	1		2
Function 1	off		off
Function 2	off		off
Function 3	off		off
Switching elements (relays)	1		2
Test	on		on
Relay mode	N/C operation		N/C operation
Function 1	Ins. alarm 1		Ins. alarm 2
Function 2	Connection fault		Device error
Function 3	off		Connection fault
Interfaces			
DHCP	off		
IP address	192.168.0.5		
Subnet mask	255.255.255.0		
BCOM name	system-1-0*		
Device address BS bus	1		
isoData	Mode 1		
Modbus RTU	via RS485		
Address	100		
Baud rate	19.2 kBd		
Parity	even		
Stop bits	1		

* The BCOM name is not changed when the factory settings are restored.

Special functions	
ISOnet	off
ISOloop	off

EDS insulation fault location	
Mode	auto
Current	10 mA
EDSsync	off

13.2 Device profiles

i When switching a profile, the value of R_{min} is reset. Switching a profile may result in longer measuring times.

Adjustments to different applications can be made by selecting a device profile. The following device profiles are available:

Power circuits

Main circuits without dynamic frequency changes. The universal profile is suitable for all systems with primarily constant system frequencies and extraneous DC voltages. When using inverters and dynamic frequency control, select **inverters > 10 Hz** or **inverters < 10 Hz**.

U_n	F_n	C_e	U_m	Measuring range	Response values
AC 0...690 V DC 0...1000 V	15...460 Hz	0...150 μ F	\pm 50 V	0.1 k Ω ... 2.0 M Ω	1 k Ω ... 10 M Ω

Response time "Power circuits" profile as a function of response value and system leakage capacitance acc. to IEC 61557-8 ($U_n = 690$ V, $f = 50$ Hz) measuring range < 10 M Ω

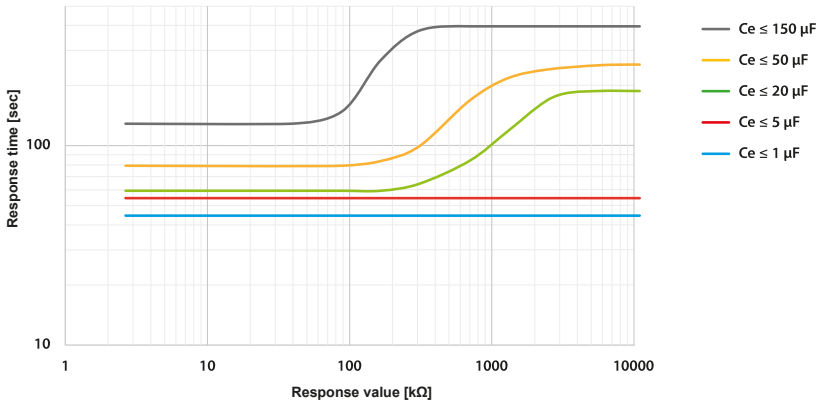

Control circuits

This profile is used to reduce the measurement voltage to $\pm 10\text{ V}$ in control systems with lower nominal voltages in order to reduce the impact by the ISOMETER® on sensitive switching elements.

U_n	F_n	C_e	U_m	Measuring range	Response values
AC 0...230 V DC 0...230 V	15...460 Hz	0...150 μF	$\pm 10\text{ V}$	0.1 k Ω ... 20 M Ω	1 k Ω ... 10 M Ω

Response time "Control circuits" profile as a function of response value and system leakage capacitance acc. to IEC 61557-8 ($U_n = 690\text{ V}$, $f = 50\text{ Hz}$) measuring range $< 10\text{ M}\Omega$

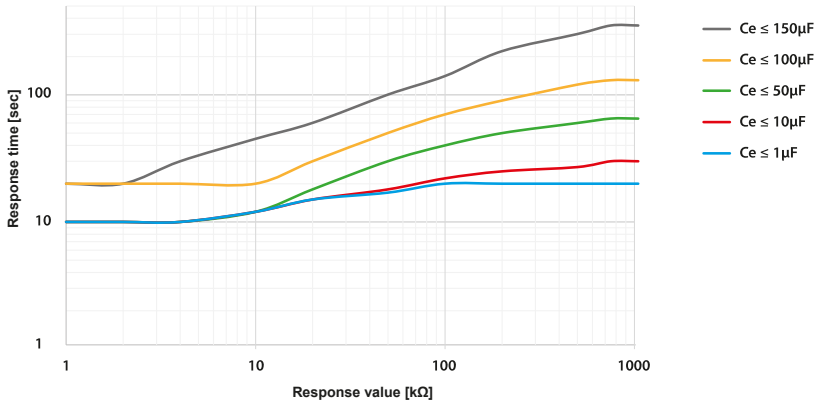

Generator

This profile allows the realisation of a very fast measuring time, e.g. as required for generator monitoring. Furthermore, this profile can be used to support fast fault location in an IT system. The generator profile is suitable for AC systems containing DC components.

U_n	F_n	C_e	U_m	Measuring range	Response values
AC 0...690 V	50...60 Hz	0...5 μ F	\pm 50 V	0.1 k Ω ... 20 M Ω	1 k Ω ... 10 M Ω

Response time "Generator" profile as a function of response value and system leakage capacitance acc. to IEC 61557-8 ($U_n = 690$ V, $f = 50$ Hz) measuring range < 10 M Ω

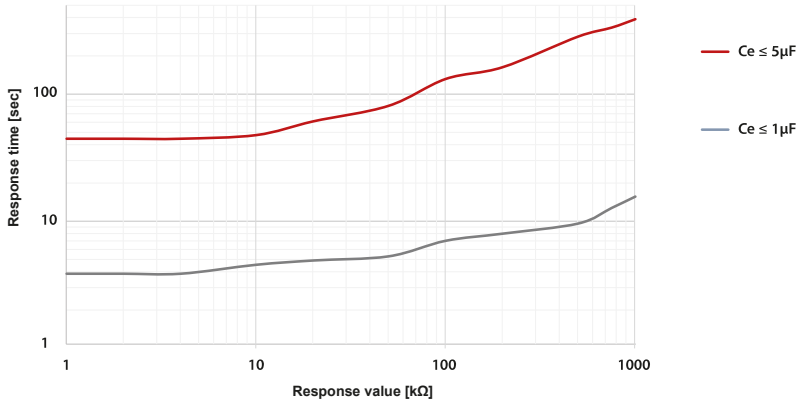

High capacitance

For systems with high system leakage capacitances, e.g. ship applications, the impact of system leakage capacitances on the measuring result can be significantly reduced by selecting this profile.

U_n	F_n	C_s	U_m	Measuring range	Response values
AC 0...690 V DC 0...1000 V	15...460 Hz	0...1000 μ F	\pm 50 V	0.1 k Ω ... 20 M Ω	1 k Ω ... 10 M Ω

Response time "High capacitance" profile as a function of response value and system leakage capacitance acc. to IEC 61557-8 ($U_n = 690$ V, $f = 50$ Hz) measuring range < 10 M Ω

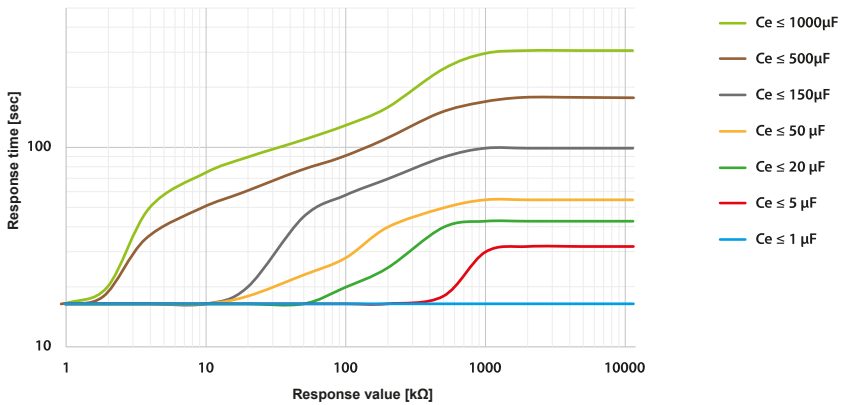

Inverter > 10 Hz

This profile is used for systems with dynamic frequency control by inverters in the range 10...460 Hz in order to optimise the measurement with respect to the measuring time and quality.

U_n	F_n	C_g	U_m	Measuring range	Response values
AC 0...690 V DC 0...1000 V	10...460 Hz	0...20 μ F	\pm 50 V	0.1 k Ω ... 20 M Ω	1 k Ω ... 10 M Ω

Response time "Inverter > 10 Hz" profile as a function of response value and system leakage capacitance acc. to IEC 61557-8 ($U_n = 690$ V, $f = 50$ Hz) measuring range < 10 M Ω

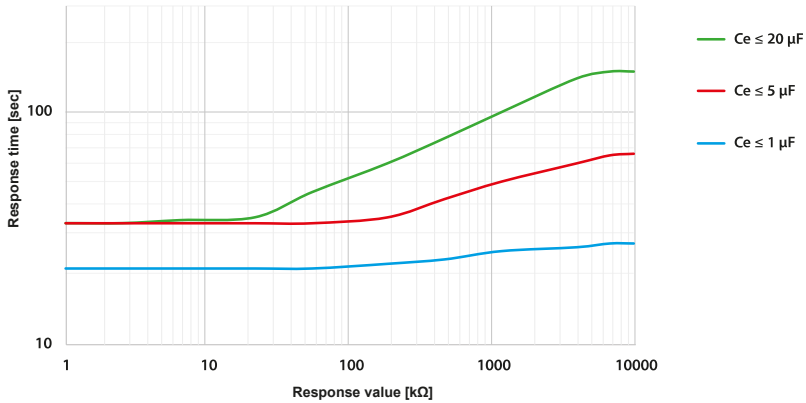

Inverter < 10 Hz

For systems involving extremely low-frequency frequency controls in the range of up to 0.1...460 Hz and very slowly and continuously changing extraneous DC voltages due to dynamic load conditions in an IT system, continuous insulation monitoring can be optimised using this profile.

U_n	F_n	C_e	U_m	Measuring range	Response values
AC 0...690 V DC 0...1000 V	0.1...460 Hz	0...20 μ F	\pm 50 V	0.1 k Ω ... 20 M Ω	1 k Ω ... 10 M Ω

Response time "Inverter < 10 Hz" profile as a function of response value and system leakage capacitance acc. to IEC 61557-8 ($U_n = 230$ V, $f = 50$ Hz) measuring range < 10 M Ω

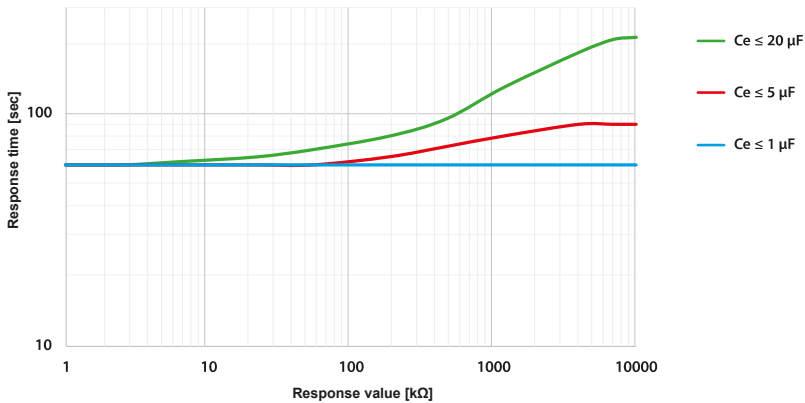

i For very low-frequency systems, the nominal system voltage is reduced in accordance with the specifications in "Tabular data iso685-x-P", page 121.

Customer-specific

Enables Bender Service to make customised measurement settings to make customised measurement settings. If no settings have been made by Bender Service, the profile has the same parameters as the **Power circuits** profile.

U_n	F_n	C_e	U_m	Measuring range	Response values
-	-	-	-	-	-

13.3 Tabular data iso685-x-P

Insulation coordination acc. to IEC 60664-1/-3

Rated voltage	1000 V
Overvoltage category	III
Altitude	3000 AMSL

Definitions

Measuring circuit (IC1)	L1/+, L2, L3/–
Supply circuit (IC2)	A1, A2
Output circuit 1 (IC3)	11, 12, 14
Output circuit 2 (IC4)	21, 22, 24
Control circuit (IC5)	E, KE, X1, ETH, X3, X4

Rated impulse voltage

IC1/(IC2-5)	8 kV
IC2/(IC3-5)	4 kV
IC3/(IC4-5)	4 kV
IC4/IC5	4 kV

Rated insulation voltage

IC1/(IC2-5)	1000 V
IC2/(IC3-5)	250 V
IC3/(IC4-5)	250 V
IC4/IC5	250 V
Pollution degree outside ($U_n < 690$ V)	3
Pollution degree outside (690 V $< U_n < 1000$ V)	2

Protective separation (reinforced insulation) between

IC1/(IC2-5)	Overvoltage category III, 1000 V
IC2/(IC3-5)	Overvoltage category III, 300 V
IC3/(IC4-5)	Overvoltage category III, 300 V
IC4/IC5	Overvoltage category III, 300 V

Voltage test (routine test) according to IEC 61010-1

IC2/(IC3-5)	AC 2.2 kV
IC3/(IC4-5)	AC 2.2 kV
IC4/IC5	AC 2.2 kV

Supply voltage

Supply via A1/+, A2/-

Supply voltage range U_s	AC/DC 24...240 V
Tolerance of U_s	-30...+15 %
Maximum permissible input current of U_s	650 mA
Frequency range of U_s	DC, 50...400 Hz *
Tolerance of U_s frequency range	-5...+15 %
Power consumption, typical at DC	≤ 12 W
Power consumption, typical at 50/60 Hz	≤ 12 W/21 VA
Power consumption, typical at 400 Hz	≤ 12 W/45 VA

* At frequencies > 200 Hz, the connection of X1 and remote must be shockproof. Only permanently installed devices which at least have overvoltage category II (300 V) may be connected.

Supply via X1

Supply voltage U_s	DC 24 V
Tolerance of U_s	-20...+25 %

IT system being monitored

Nominal system voltage range U_n	AC 0...690 V, DC 0...1000 V
Nominal system voltage range U_n for UL applications	AC/DC 0...600 V
Tolerance of U_n	AC/DC +15 %
Frequency range of U_n	DC 0.1...460 Hz
Max alternating voltage U^- (for $f_n < 4$ Hz)	$U^-_{\max} = 50 \text{ V} * (1 + f_n^2 / \text{Hz}^2)$

Response values

Response value R_{an1} (ALARM 1)	1 kΩ...10 MΩ
Response value R_{an2} (ALARM 2)	1 kΩ...10 MΩ
Relative uncertainty (acc. to IEC 61557-8)	profile-dependent, ±15 %, min. ±1 kΩ
Hysteresis	25 %, min. 1 kΩ

Time response

Response time t_{an} at $R_f = 0.5 \times R_{an}$ (10 kΩ) and C_e (1 μF) acc. to IEC 61557-8	profile-dependent, typ. 4 s
Response time DC alarm at $C_e = 1 \mu\text{F}$	profile-dependent, typ. 2 s
Start-up delay t_{start}	0 s ... 10 min

Measuring circuit

Measuring voltage U_m	profile-dependent, $\pm 10\text{ V}$, $\pm 50\text{ V}$ (see device profiles)
Measuring current I_m	$\leq 403\ \mu\text{A}$
Internal resistance R_i, Z_i	$\geq 124\ \text{k}\Omega$
Permissible extraneous DC voltage U_{fg}	$\leq 1200\text{ V}$
Permissible system leakage capacitance C_e	profile-dependent, $0 \dots 1000\ \mu\text{F}$
Test current	1 / 1.8 / 2.5 / 5 / 10 / 25 / 50 mA

Measuring ranges

Measuring range f_n	0.1...460 Hz
Tolerance, measurement of f_n	$\pm 1\% \pm 0.1\text{ Hz}$
Voltage range, measurement of f_n	AC 25...690 V
Measuring range U_n	AC 25...690 V, DC 0...1000 V
Voltage range, measurement of U_n	AC/DC > 10 V
Tolerance, measurement of U_n	$\pm 5\% \pm 5\text{ V}$
Measuring range C_e	0...1000 μF
Tolerance, measurement of C_e	$\pm 10\% \pm 10\ \mu\text{F}$
Frequency range, measurement of C_e	DC 30...460 Hz
Insulation resistance, measurement of C_e depending on the profile and coupling mode	typ. > 10 k Ω

Display

Display	Graphic display 127 x 127 pixel, 40 x 40 mm *
Display range, measured value	0.1 k Ω ...20 M Ω
Operating uncertainty (acc. to IEC 61557-8)	$\pm 15\%$, min. 1 k Ω

* Indication is limited outside the temperature range -25...+55 °C.

LEDs

ON (operation LED)	green
PGH	yellow
SERVICE	yellow
ALARM 1	yellow
ALARM 2	yellow

Inputs/outputs (X1)

Cable length X1 (unshielded cable)	≤ 10 m
Cable length X1 (unshielded cable, shield connected to PE on one side) recommended: J-Y(St)Y min. 2x0.8	≤ 100 m
Max output current for supply via X1+/X1GND per output	1 A
Max output current for supply via A1/A2 in total on X1	200 mA
Max output current for supply via A1/A2 in total on X1 between 16.8 V and 40 V	$I_{LmaxX1} = 10 \text{ mA} + 7 \text{ mA} / V \times U_s^*$

* U_s is the supply voltage of the ISOMETER®.
Negative values for I_{LmaxX1} are not permissible.

Digital inputs (I1, I2, I3)

Number	3
Operating mode, adjustable	high-active, low-active
Functions	off, test, reset, deactivate device, start initial measurement
Voltage	Low DC -3...5 V, High DC 11...32 V
Voltage tolerance	±10 %

Digital outputs (Q1, Q2)

Number	2
Operating mode, adjustable	active, passive
Functions	off, Ins. Alarm 1, Ins. Alarm 2, connection fault, DC- alarm *, DC+ Alarm *, symmetrical alarm, device error, common alarm, measurement complete, device inactive, DC offset alarm
Voltage	passive DC 0...32 V, active DC 0 / 19.2...32 V

* Only for $U_n \geq 50 \text{ V}$

Analogue output (M+)

Number	1
Operating mode, adjustable	linear, midscale point 28 kΩ/120 kΩ
Functions	insulation value, DC offset
Current	0...20 mA (< 600 Ω) 4...20 mA (< 600 Ω) 0...400 μA (< 4 kΩ)
Voltage	0...10 V (>1 kΩ) 2...10 V (>1 kΩ)
Tolerance related to the current/voltage final value %	±20 %

Interfaces

Field bus

Interface/protocol	web server/Modbus TCP/BCOM
Data rate	10/100 Mbit/s, autodetect
Max. number of Modbus requests	< 100/s
Cable	min. CAT 6
Cable length	≤ 100 m
Connection	RJ45
IP address	DHCP/manually: 192.168.0.5
Net mask	255.255.255.0
BCOM address	system-1-0
Function	Communication interface

ISOnet

ISOnet number of devices	2...20
Maximum nominal system voltage ISOnet	AC, 690 V/DC, 1000 V

EDSsync

EDSsync number of devices	2...10
---------------------------	--------

ISOloop

ISOloop number of devices	2...10
---------------------------	--------

Sensor bus

Interface / protocol	RS-485 / isoData, BS bus, Modbus RTU
Data rate Mode 1	9.6 kBd
Cable: twisted pairs, shield connected to PE on one side	recommended: J-Y(St)Y min. 2×0.8
Cable length (depending on the baud rate)	≤ 1200 m
Connection	terminals X1A, X1B
Terminating resistor	120 Ω, can be connected internally
Device address	1...90

Switching elements

Switching elements	2 changeover contacts
Relay mode	normally closed/normally open operation
Contacts (11-12-14 / 21-22-24)	off, Ins. Alarm 1, Ins. Alarm 2, connection fault, DC– alarm *,DC+ alarm *, symmetrical alarm, device error, common alarm, measurement complete, device inactive, DC offset alarm

Electrical endurance at rated operating conditions

10,000 operating cycles

* Only for $U_n \geq 50$ V

Contact data acc. to IEC 60947-5-1

Utilisation category	AC-13 / AC-14 / DC-12 / DC-12 / DC-12 / DC-12
Rated operational voltage	230 V / 230 V / 24 V / 48 V / 110 V / 220 V
Rated operational current	5 A / 3 A / 1 A / 1 A / 0.2 A / 0.1 A
Rated insulation voltage at ≤ 2000 m AMSL	250 V
Rated insulation voltage at ≤ 3000 m AMSL	160 V
Minimum contact rating	1 mA at AC/DC ≥ 10 V

Environment & EMC

EMC	IEC 61326-2-4
Operating temperature	-25...+55 °C
Transport	-40...+85 °C
Long-term storage	-40...+70 °C

Classification of climatic conditions acc. to IEC 60721 (with respect to temperature and rel. humidity)

Stationary use (IEC 60721-3-3)	3K22
Transport (IEC 60721-3-2)	2K11
Long-term storage (IEC 60721-3-1)	1K22

Classification of mechanical conditions acc. to IEC 60721

Stationary use (IEC 60721-3-3)	3M11
Transport (IEC 60721-3-2)	2M4
Long-term storage (IEC 60721-3-1)	1M12
Area of application	≤ 3000 m AMSL

Connection

Connection type screw-type terminal or push-wire terminal, pluggable

Screw-type terminals

Nominal current	≤ 10 A
Tightening torque	0.5...0.6 Nm (5...7 lb-in)
Conductor sizes	AWG 24-12
Stripping length	7 mm

Screw-type terminals

rigid/flexible	0.2...2.5 mm ²
flexible with ferrule with/without plastic sleeve	0.25...2.5 mm ²
Multiple conductor, rigid	0.2...1 mm ²
Multiple conductor, flexible	0.2...1.5 mm ²
Multiple conductor, flexible with ferrule without plastic sleeve	0.25...1 mm ²
Multiple conductor, flexible with TWIN ferrule with plastic sleeve	0.5...1.5 mm ²

Push-wire terminals

Nominal current	≤ 10 A
Conductor sizes	AWG 24-12
Stripping length	10 mm
rigid/flexible	0.2...2.5 mm ²
flexible with ferrule with/without plastic sleeve	0.25...2.5 mm ²
Multiple conductor, flexible with TWIN ferrule with plastic sleeve	0.5...1.5 mm ²

Push-wire terminals X1

Nominal current	≤ 8 A
Conductor sizes	AWG 24-16
Stripping length	10 mm
rigid/flexible	0.2...1.5 mm ²
flexible with ferrule with/without plastic sleeve	0.25...1.5 mm ²
flexible with ferrule with plastic sleeve	0.25...0.75 mm ²

Other

Operating mode	continuous operation
Mounting position	display-oriented *
Degree of protection, internal components	IP40
Degree of protection, terminals	IP20
DIN rail mounting acc. to	IEC 60715
Screw mounting	3 x M4 with mounting clip
Enclosure material	polycarbonate
Flammability class	V-0
ANSI Code	64
Dimensions (W × H × D)	108 × 93 × 110 mm
Weight	< 390 g

* For best ventilation, align cooling slots vertically (0°).

At an alignment of 45° the max. operating temperature is reduced by 10 °C.

At an alignment fo 90° the max. operating temperature is reduced by 20 °C.

Option “W”, data different from the standard version

Devices with the suffix **W** feature increased shock and vibration resistance. The electronics is covered with a special varnish to provide increased protection against mechanical stress and moisture.

Rated operational current for switching elements max. 3 A (for UL applications)

Ambient temperatures

Operating temperature	-40...+70 °C
Operating temperature for UL applications	-40...+65 °C
Transport	-40...+85 °C
Long-term storage	-40...+70 °C

Classification of climatic conditions acc. to IEC 60721

Stationary use (IEC 60721-3-3)	3K23
--------------------------------	------

Classification of mechanical conditions acc. to IEC 60721

Stationary use (IEC 60721-3-3)	3M12
--------------------------------	------

i *Combination of ISOMETER® sensor variant with an FP200W: The requirements of option **W** will only be fulfilled when the ISOMETER® sensor variant is mounted on a DIN rail and connected to the FP200W via the patch cable. Refer also to the quick-start guide FP200 (Document number D00169).*

Standards and certifications

The ISOMETER® has been developed in compliance with the following standards:

- DIN EN 61557-8 (VDE 0413-8): 2015-12
- IEC 61557-8: 2014-12
- IEC 61557-8: 2014/COR1:2016
- DIN EN 61557-8 Cor 1 (VDE 0413-8 Cor 1): 2016-12
- IEC 61557-9

Subject to change! The specified standards take into account the edition valid until 14.03.2024 unless otherwise indicated.



13.4 Ordering details

Device

Type	Supply voltage U_s	Article number
iso685-D-P	AC 24...240 V; 50...400 Hz; DC 24...240 V	B91067030
iso685W-D-P*	AC 24...240 V; 50...400 Hz; DC 24...240 V	B91067030W
iso685-S-P + FP200	AC 24...240 V; 50...400 Hz; DC 24...240 V	B91067230
iso685W-S-P + FP200W*	AC 24...240 V; 50...400 Hz; DC 24...240 V	B91067230W

* Option **W**: Increased shock and vibration resistance 3K23; 3M12; Bezeichnung -40...+70 °C

Accessories

Description	Article number
iso685 Mechanical accessories comprising terminal cover, 2 mounting clips *	B91067903
iso685 connector kit for screw-type terminals *	B91067901
iso685 connector kit for push-wire terminals	B91067902
BB bus 6TE connector	B98110001

* included in the scope of delivery

Suitable system components

Type	Description	Article number
7204-1421 9604-1421 9620-1421	Suitable measuring instruments mid scale: 28 kΩ; 120 kΩ Current values: 0...400 μA; 0...20 mA	B986763 B986764 B986841
FP200 FP200W*	Display for front panel mounting	B91067904 B91067904W
iso685-S-P	ISOMETER® sensor variant * AC 24...240 V; 50...400 Hz; DC 24...240 V	B91067130
iso685W-S-P	ISOMETER® sensor variant * AC 24...240 V; 50...400 Hz; DC 24...240 V	B91067130W

* Only available with separate FP200(W) panel

Insulation fault locators

Type	Supply voltage U_S *	Response value	Article number
EDS440-S-1	AC/DC 24...240 V	2...10 mA	B 9108 0201
EDS440W-S-1	AC/DC 24...240 V	2...10 mA	B 9108 0201W
EDS440-L-4	AC/DC 24...240 V	2...10 mA	B 9108 0202
EDS440W-L-4	AC/DC 24...240 V	2...10 mA	B 9108 0202W
EDS441-S-1	AC/DC 24...240 V	0.2...1 mA	B 9108 0204
EDS441W-S-1	AC/DC 24...240 V	0.2...1 mA	B 9108 0204W
EDS441-L-4	AC/DC 24...240 V	0.2...1 mA	B 9108 0205
EDS441W-L-4	AC/DC 24...240 V	0.2...1 mA	B 9108 0205W
EDS441-LAB-4	AC/DC 24...240 V	0.2...1 mA	B 9108 0207
EDS441W-LAB-4	AC/DC 24...240 V	0.2...1 mA	B 9108 0207W

* Absolute values

13.5 Document revision history

Date	Document version	Valid from software version	State/Changes
02/2021	09	D0440 V1.28 D0439 V1.27	Editorial Revision Added <ul style="list-style-type: none"> – Menu item ‚Behaviour when inactive‘ – Chapter 9.2 (2.4) Display of values in the ‚group settings‘ – Contact data Relay – UKCA-Certificate – Revision history
03/2024	10	"	Changes <ul style="list-style-type: none"> – “Caution: This equipment is not intended for use in residential environments and may not provide adequate protection to radio reception in such environments.”, page 10 according to VDE; removed from tabular data – Figure “Linear”, page 59: value changed from 100 Ω to 10 kΩ Added <ul style="list-style-type: none"> – Section “Factory setting”, page 76 Editorial revision with transfer to SMC (D00170_iso685-x-P)

14 Glossary

BB bus	The BB bus is an interface which enables Bender devices to communicate with each other (Bender-internal device bus). The BB bus can be used with an ISOMETER® and one or more EDS44...-S.
BCOM	Protocol for communication between Bender devices via an IP-based network.
BS bus	The Bender sensor bus is an interface which enables Bender devices to communicate with each other (RS-485 interface).
DHCP	Dynamic Host Configuration Protocol. It is used to assign the network configuration to Clients via a server.
EDS	Insulation fault locator for fault location in an IT system.
EDSync	Synchronous distribution of trigger information in coupled systems.
EDS button	The shortcut button EDS manually starts the insulation fault location, which runs continuously until the button is pressed again, which stops the process immediately.
EDS mode	The insulation fault location can be carried out in three different modes. Depending on the mode, the insulation fault location starts and stops due to different conditions.
ISOnet	Only one ISOMETER® may exist in an isolated system. If several networks monitored by an ISOMETER® are coupled, this function ensures via an Ethernet connection that only one ISOMETER® is actively measuring.
ISOnet priority	This function makes it possible to give permanent priority to a device in ISOnet mode or to get priority. After 12 hours, the device returns to normal mode.
ISOloop	Special function for ring systems (all systems are coupled). The ISOloop mode is activated via the information of the dig. input (switch state). If all devices are in this mode, the device with the lowest BCOM address continues to measure.
Modbus TCP	Modbus is an internationally widely-used protocol for data transmission. The data are transmitted via the TCP protocol.
Modbus RTU	The data are transmitted via the RS-485 protocol.
PGH	PGH stands for locating current injector. The locating current injector generates a periodic locating current for insulation fault location. This locating current is detected by the measuring current transformers connected to the EDS and evaluated by the EDS.
“PGH ON” LED	The PGH ON LED flashes during insulation fault location. It indicates that the locating current for the insulation fault location is generated.
system (BCOM)	The system is the entire installation that is visible to the customer and defined by the customer. The BCOM communication takes place within this system. Naturally, different systems can exist independently in one network.
subsystem (BCOM)	The subsystem structures parts of the system as units defined by the customer, e.g. all PQ devices. A typical subsystem are also non BCOM-capable devices that are hidden behind a proxy.
web server	A web server represents the device functions graphically. The web server can be used for reading out measured values and for parameter setting.



Bender GmbH & Co. KG

Londorfer Straße 65
35305 Grünberg
Germany

Tel.: +49 6401 807-0
info@bender.de
www.bender.de

Alle Rechte vorbehalten.
Nachdruck und Vervielfältigung nur mit
Genehmigung des Herausgebers.

All rights reserved.
Reprinting and duplicating only with
permission of the publisher.

© Bender GmbH & Co. KG, Germany
Subject to change! The specified
standards take into account the edition
valid until unless otherwise indicated.

